



Titan Chain & Supply, LLC

Effective Date May 2022

Traction Catalog 2022

ALL YOUR TRACTION NEEDS

PASSENGER

LIGHT TRUCK

HEAVY TRUCK

HEAVY EQUIPMENT

GARDEN TRACTOR

ATV

CDOT
Approved
ATD

TIRE
SOCKS



Warranty

Warranty: The products in this catalog are warranted free from defects in workmanship and materials for 30 days after purchase date.

Disclaimer of Warranties: No other warranty expressed or implied, including warranty of merchantability or fitness for a particular purpose, is given and no affirmation of Seller, by words or action shall constitute a warranty.

Buyer Remedies: Buyers sole remedy for breach of any warranty, is limited exclusively to obtaining at the discretion of the seller, either repair or replacement of any product sold hereunder and manufactured by seller be liable for any incidental or consequential damages. Buyer must notify seller in writing within 10 days of discovery of the alleged defect and within the warranty period stated above.

Return Freight Policy: After receiving authorization from Seller, product shall be returned to Sellers plant. Transportation prepaid, within 30 Days.

Direct Correspondence to: TITAN CHAIN & SUPPLY, LLC

Important Information

Tires: The use of a traction device can cause scuffing of tires when installed, as well as scuffing during use. This is unavoidable with many of today's tread types and designs.

Wheels: The use of a traction device can cause scuffing of wheels. Large diameter wheels with low profile tires such as 30, 35, 40, 45 and 50 series tires are at greater risk due to low sidewall heights.

Liability Disclaimer: The use of a traction device is at the risk of the vehicle operator. Vehicle operators who are not willing to accept the risk of tire and wheel scuffing, due to installation of a traction device, should not install or use traction devices on their vehicle and should find other modes of safe transportation. Under no circumstances will Titan Chain & Supply, LLC consider giving compensation for the repair of, or replacement of tires or wheels as a result of installation and/or use of a traction device.

Vehicles: Traction devices are made for use on snow and ice. Use of a traction device on bare pavement and/or at speeds over 30mph greatly reduces the service life of the traction device and increases the chance for component failure of the traction device. The use of a traction device which has broken is unsafe and can cause damage to the vehicle it is being used on. Vehicle operator should pull over to a safe place immediately and repair or replace the traction device.

Freight and Return Policies

Over 1,000 pounds or \$2,000 - Freight charges FOB destination within Continental US (excluding AK and HI).

All eligible prepaid shipments are routed at Titan Chain & Supply, LLC's option. Allowed prepaid shipment costs are limited to the carrier's tariff rates for transportation. Extra charges such as duties, broker fees, lift gate fees, delivery notification fees, fuel surcharges, taxes, etc. will be prepaid and invoiced to the buyer. Qualifying shipment to Alaska and Hawaii will be prepaid to the port of departure in the Continental US under the terms of this freight policy. Buyer should promptly inventory each shipment upon receipt. Any discrepancies must be submitted within 24 hours of receipt of shipment. Claims will not be considered unless an exception is noted on the original freight bill.

Return Policy:

1. RGA Required. No returned merchandise will be accepted without prior written authorization.
2. All items must be in resalable condition.
3. All returned merchandise is subject to a 20% restocking/handling fee at Titan Chain & Supply, LLC's discretion.
4. Freight/Transportation costs must be prepaid to Titan Chain & Supply, LLC's warehouse. Returns shipped Collect or unauthorized returns will be REFUSED.
5. Custom items are not returnable.
6. RGA's expire 30 days after issue date. If return is not received by Titan Chain & Supply, LLC within 30 days of RGA issue date, a NEW RGA will be required.

HOW TO CORRECTLY CHOOSE A TRACTION DEVICE FOR YOUR VEHICLE

- Look at owner's manual to find out clearance on your vehicle
- Choose the correct category from the index in the front of this catalog: Passenger Car, Light Truck, Truck, Etc.
- Find tire size from the tire (usually located on the side of the tire).
- Select traction device that best fits customers need.

Warranty, Freight Policies	2
Table of Contents	3
FIT CHARTS	
Passenger	4-13
Light Truck	14-20
Truck	20-22
Tractor	22
Loader, Grader	23
PASSENGER TIRE CHAINS	
Cable (1000 series) Diagonal Cable (300 series)	24
Tire Sock	24
PL Link, Regular, V-Bar (1100, 1200, 1800 series)	25
Titan Diamond (1500 series)	25
LIGHT TRUCK TIRE CHAINS	
Cable (2000, 3000 series) Diagonal Cable (700 series)	26
Tire Sock	26
Titan Diamond (2300, 2500 series)	27
Regular, Cam, Non-Cam, Singles, Duals (2200, 3200, 4200 series)	28
V-Bar, Cam, Non-Cam, Singles, Duals (2800, 3800, 4800 series)	29
Square Link Cam and Heavy Duty (2200SCAM, 3200SCAM, 4200SCAM,) (2200SHD, 4200SHD)	30
Mud Service (2400, 3400, 4400 series)	31
HEAVY TRUCK TIRE CHAINS	
Cable (2000, 3000, 4000) Diagonal Cable (800 series)	32
Tire Sock	32
Regular, V-Bar, Cam, Non-Cam, Singles, Duals (2200, 4200 series) (2800, 4800 series)	33
Round Twist Alloy, Regular and Heavy Duty (2200ACAM, 2200AHDCAM, 4200ACAM, 4200AHDCAM)	34
Square Link Alloy, Regular, Heavy Duty, (2200SCAM, 2200SHDCAM, 4200SHDCAM)	34
Twisted Square Link Alloy, and Heavy Duty, (2200STCAM, 4200STCAM)	35
Studded, (2200STUD, 4200STUD)	35
Mud Service (2400, 4400 series)	35
Wide Base, Regular, Square Link Alloy (3200 series)	36
Titan Diamond Square Link Alloy	36
TRACTOR TIRE CHAINS	
Regular Ladder Type, Square Link Ladder Type, Box Pattern (0800, 0800S, HP series)	37-38
LOADER, GRADER, SKID STEER, FORKLIFT CHAINS	
Regular Ladder and Square Link Alloy Ladder Type (2600, 2600S series)	39
Titan HP (7100HP) Titan Diamond (7100DLW)	40
Skid Steer Square Link Alloy (SS series)	41
Forklift (1400 series)	41
FORESTRY CHAINS	
Ring, Tight Ring, Double Diamond Net	42
GARDEN TRACTOR, ATV CHAINS	
43	
ACCESSORIES, REPAIR PIECES, TOOLS	
Continuous Cross Chain, Continuous Side Chain, Cam Side Chain	44-45
Cams, Cross Chain Hooks, Cam Tools, Repair Links, Repair Pieces	45-46
Fasteners, Shoe Chains, Pliers, Cutters, Shackles, Grab Hooks, Tire Chain Adjusters, Tarp Straps	47-48
Replacement Cross Chain	49-50
SAE Clearance Classifications, State Chain Requirements	52
CARGO CONTROL	
Tie-Downs, Transport Chains, Binders, Interior Van Products, Accessories	51-52

(Continued on next page)

PASSENGER FIT CHART**Guide only, please check - Actual fit and/or clearance can vary.**

Tire Size	Tire Sock	Ladder Cable	Diagonal Cable 300/700	Type "PL" 1100	Car Chain 1200	V-Bar 1800	Diamond 1500, 2300, 2500
	Pg. 24	Pg. 24	Pg. 24	Pg. 25	Pg. 25	Pg. 25	Pg. 25
13"		Class (S)	Class (S)	Class (S)	Class (U)	Class (U)	Class (S)
135/70-13	H54						
135/80-13	H54			1110			1505
145/60-13	H54						
145/65-13	H54						
145/70-13	H54	1014		1110			1505
145/80-13	H58	1014		1114			1510
155/60-13	H54						1505
155/65-13	H54						
155/70-13	H54	1014		1114			1510
155/80-13	H58	1014	TC-315DC	1114			1515
165/55-13	H54						
165/60-13	H54	1014		1114			1505
165/65-13	H54	1014		1114			1510
165/70-13	H58	1014		1114			1510
165/75-13	H58	1014	TC-315DC	1114			1515
165/80-13	H62	1018	TC-319DC	1118	1230	1830	1520
175/50-13	H54	1014		1114			
175/55-13	H54						
175/60-13	H54	1014		1114			1515
175/65-13	H58	1014		1114			1515
175/70-13	H58	1018	TC-315DC	1118			1520
175/75-13	H62	1018	TC-319DC	1118			1525
175/80-13	H62	1022	TC-319DC	1122	1230	1830	1525
185/55-13	H54						
185/60-13	H54	1018	TC-315DC	1118			1515
185/65-13	H58	1018	TC-315DC	1118			1520
185/70-13	H58	1026	TC-319DC	1126	1230	1830	1525
185/75-13	H62	1026	TC-323DC	1126	1230	1830	1525
185/80-13	H62	1022	TC-319DC	1122	1230	1830	1530
185/85-13	H66	1030	TC-327DC	1130			
195/45-13	H54						
195/55-13	H54	1018	TC-315DC	1118			1515
195/60-13	H58	1026	TC-315DC	1126	1230	1830	1520
195/65-13	H58	1026	TC-319DC	1126			1525
195/70-13	H62	1026	TC-323DC	1126	1230	1830	1525
195/75-13	H62	1030	TC-327DC	1130			1525
205/60-13	H58	1026	TC-319DC	1126	1230	1830	1525
205/65-13	H62		TC-323DC				1530
205/70-13	H62	1030	TC-327DC	1130	1230	1830	1530
215/50-13	H54	1026	TC-323DC	1126			
215/60-13	H58	1026	TC-323DC	1126	1230	1830	1530
215/65-13	H62	1030	TC-331DC	1130			
225/55-13	H58						
225/60-13	H62						
235/50-13	H58	1034	TC-323DC	1134	1230	1830	
235/60-13	H62	1034	TC-327DC	1134	1230	1830	1535
245/50-13	H58	1034	TC-315DC	1134	1230	1830	

(Continued on next page)

PASSENGER FIT CHART

Guide only, please check - Actual fit and/or clearance can vary.

Tire Size	Tire Sock	Ladder Cable	Diagonal Cable 300/700	Type "PL" 1100	Car Chain 1200	V-Bar 1800	Diamond 1500, 2300, 2500
	Pg. 24	Pg. 24	Pg. 24	Pg. 25	Pg. 25	Pg. 25	Pg. 25
14"		Class (S)	Class (S)	Class (S)	Class (U)	Class (U)	Class (S)
135/70-14	H54						
135/80-14	H58						
145/65-14	H54						
145/70-14	H58	1014		1114			1510
145/80-14	H58						
155/65-14	H58	1014		1114			1510
155/70-14	H58	1018	TC-315DC	1118			1515
155/80-14	H62						
165/55-14	H54						
165/60-14	H54	1014		1114			1515
165/65-14	H58	1018	TC-315DC	1118			1515
165/70-14	H58	1018	TC-315DC	1118			1520
165/75-14	H62	1018	TC-319DC	1118			1525
165/80-14	H62	1018	TC-319DC	1118			1525
175/50-14	H54	1014		1114			
175/60-14	H58	1018	TC-315DC	1118			1515
175/65-14	H58	1018	TC-319DC	1118			1520
175/70-14	H62	1026	TC-319DC	1126			1525
175/75-14	H62	1022	TC-319DC	1122	1230	1830	1525
175/80-14	H62	1022	TC-323DC	1122			1530
185/50-14	H54	1018		1118			1515
185/55-14	H58	1018	TC-315DC	1118			1515
185/60-14	H58	1018	TC-319DC	1118	1230	1830	1525
185/65-14	H62	1026	TC-319DC	1126	1230	1830	1525
185/70-14	H62	1026	TC-323DC	1126	1230	1830	1530
185/75-14	H62	1026	TC-323DC	1126	1240	1840	1530
185/80-14	H66	1030	TC-331DC	1130	1240	1840	1535
195/40-14	H54						
195/45-14	H54						
195/50-14	H54						
195/55-14	H58	1022	TC-319DC	1122			1525
195/60-14	H58	1026	TC-319DC	1126	1230	1830	1525
195/65-14	H62	1026	TC-323DC	1126	1230	1830	1530
195/70-14	H62	1030	TC-327DC	1130	1240	1840	1530
195/75-14	H66	1030	TC-329DC	1130	1240	1840	1535
195/80-14	H66			1134			1540
205/50-14	H58						
205/55-14	H58	1026	TC-323DC	1126	1230	1830	1525
205/60-14	H62	1026	TC-323DC	1126	1230	1830	1530
205/65-14	H62	1030	TC-327DC	1130	1240	1840	1535
205/70-14	H66	1030	TC-329DC	1130	1240	1840	1540
205/75-14	H66	1034	TC-331DC	1134	1240	1840	1540
205/80-14	H66			1134			1545
215/40-14	H54						
215/60-14	H62	1030	TC-323DC	1130	1240	1840	1530
215/65-14	H62	1034	TC-331DC	1134	1240	1840	1540
215/70-14	H66	1034	TC-335DC	1134	1254	1854	1545
215/75-14	H66	1034	TC-335DC	1138	1254	1854	1545
215/80-14	H70			1138			1545
225/55-14	H62	1034	TC-327DC	1134	1230	1830	1535

(Continued on next page)

PASSENGER FIT CHART**Guide only, please check - Actual fit and/or clearance can vary.**

Tire Size	Tire Sock	Ladder Cable	Diagonal Cable 300/700	Type "PL" 1100	Car Chain 1200	V-Bar 1800	Diamond 1500, 2300, 2500
14"	Pg. 24	Pg. 24	Pg. 24	Pg. 25	Pg. 25	Pg. 25	Pg. 25
		Class (S)	Class (S)	Class (S)	Class (U)	Class (U)	Class (S)
225/60-14	H62	1030	TC-327DC	1130	1254	1854	1540
225/65-14	H66	1034	TC-331DC	1134	1254	1854	1540
225/70-14	H66	1038	TC-335DC	1138	1254	1854	1545
225/75-14	H70	1038	TC-339DC	1138	1250	1850	1547
235/60-14	H66	1034	TC-335DC	1134	1254	1854	1545
235/70-14	H70	1038	TC-339DC	1138	1250	1850	
245/50-14	H62	1034	TC-327DC	1134			1540
245/60-14	H66	1038	TC-335DC	1138			1547
245/70-14	H70	1042	TC-339DC	1142			
255/55-14	H62	1038	TC-339DC	1138			
255/60-14	H66	1038	TC-343DC	1138			1540
265/50-14	H62	1042	TC-335DC	1142			1545
265/60-14	H66	1042	TC-343DC	1142			
275/60-14	H70	1042	TC-343DC	1142			

Tire Size	Tire Sock	Ladder Cable 1000	Diagonal Cable 300/700	Type "PL" 1100	Car Chain 1200	V-Bar 1800	Diamond 1500, 2300, 2500
15"	Pg. 24	Pg. 24	Pg. 24	Pg. 25	Pg. 25	Pg. 25	Pg. 25
		Class (S)	Class (S)	Class (S)	Class (U)	Class (U)	Class (S)
125/80-15	H58						
135/70-15	H58						
135/80-15	H62			1118			1515
145/65-15	H58	1014	TC-315DC	1114			
145/70-15	H58	1018	TC-315DC	1118			1515
145/80-15	H62	1018		1118			1520
155/60-15	H58	1014		1114			1510
155/65-15	H58						
155/70-15	H62	1018	TC-315DC	1118			1520
155/80-15	H62	1022	TC-319DC	1122	1230	1830	1525
165/60-15	H58	1018	TC-315DC	1118			1520
165/65-15	H62	1022	TC-319DC	1122			1525
165/70-15	H62	1022	TC-319DC	1122			1525
165/80-15	H66	1022	TC-323DC	1122			1530
175/50-15	H58						
175/55-15	H58	1018	TC-315DC	1118			1520
175/60-15	H58		TC-319DC				1525
175/65-15	H62	1022	TC-319DC	1122			1525
175/70-15	H62	1022	TC-319DC	1122			1530
175/75-15	H66	1022	TC-323DC	1122			1535
175/80-15	H66			1130			1535
185/45-15	H54						
185/50-15	H58						
185/55-15	H58	1022	TC-319DC	1122			1525
185/60-15	H62	1026	TC-323DC	1126	1230	1830	1525
185/65-15	H62	1026	TC-323DC	1126	1230	1830	1530
185/70-15	H66	1030	TC-323DC	1130	1240	1840	1535
185/75-15	H66	1030	TC-323DC	1130	1230	1830	1535
190/65-15		1030	TC-327DC	1130	1230	1830	1530
195/45-15	H54	1026	TC-319DC	1126			1520

PASSENGER FIT CHART

(Continued on next page)

Guide only, please check - Actual fit and/or clearance can vary.

Tire Size	Tire Sock	Ladder Cable	Diagonal Cable 300/700	Type "PL" 1100	Car Chain 1200	V-Bar 1800	Diamond 1500, 2300, 2500
15"	Pg. 24, 26	Pg. 24, 26	Pg. 24, 26	Pg. 25	Pg. 25	Pg. 25	Pg. 25, 27
		Class (S)	Class (S)	Class (S)	Class (U)	Class (U)	Class (S)
195/50-15	H58	1026	TC-319DC	1126	1230	1830	1525
195/55-15	H58	1022	TC-323DC	1122	1230	1830	1525
195/60-15	H62	1030	TC-327DC	1130	1230	1830	1530
195/65-15	H62	1030	TC-329DC	1130	1230	1830	1535
195/70-15	H66	1034	TC-329DC	1134	1240	1840	1540
195/75-15	H66	1034	TC-331DC	1134	1240	1840	1545
195/80-15	H70	1034	TC-335DC	1134	1250	1850	1545
195/85-15	H70						
200/60-15	H62						
205/50-15	H58	1026	TC-323DC	1126	1230	1830	1530
205/55-15	H62	1026	TC-327DC	1126	1230	1830	1530
205/60-15	H62	1030	TC-331DC	1130	1240	1840	1540
205/65-15	H66	1034	TC-329DC	1134	1254	1854	1540
205/70-15	H66	1034	TC-331DC	1134	1250	1850	1545
205/75-15	H70	1034	TC-335DC	1138	1250	1850	1545
205/80-15	H70			1138			1550
215/45-15	H58		TC-323DC				
215/50-15	H62	1026	TC-323DC	1126	1230	1830	1535
215/55-15	H62	1030	TC-327DC	1130			1535
215/60-15	H66	1034	TC-331DC	1138	1240	1840	1540
215/65-15	H66	1038	TC-335DC	1138	1254	1854	1545
215/70-15	H66	1038	TC-335DC	1138	1250	1850	1550
215/75-15	H70	1038	TC-339DC	1138	1250	1850	1550
215/80-15	H70						
225/45-15	H58	1026	TC-323DC	1126	1230	1830	
225/50-15	H62	1030	TC-327DC	1130	1230	1830	1535
225/55-15	H62	1034	TC-331DC	1134			1540
225/60-15	H66	1034	TC-331DC	1134			1545
225/65-15	H66	1038	TC-339DC	1138			
225/70-15	H70	1038	TC-343DC	1138	1250	1850	1553
225/75-15	H70	1042	TC-339DC	1142	1250	1850	1555
225/80-15	H70	1042		1142			
230/60-15	H66		TC-335DC	1138			1550
235/45-15	H62						
235/55-15	H66	1034	TC-339DC	1134			1545
235/60-15	H66	1038	TC-339DC	1138			1550
235/65-15	H70	1042	TC-339DC	1142			1555
235/70-15	H70	1042	TC-343DC	1142	1250	1850	1555
235/75-15	H70	1042	TC-729DC	1142	1250	1850	2319 2519
245/50-15	H62	1038	TC-331DC	1138			
245/60-15	H66	1042	TC-339DC	1142			1553
245/65-15	H66	2019	TC-343DC	1146			
245/70-15	H70	1042	TC-343DC	1142			1553
245/75-15	H74		TC-729DC				
255/45-15	H62						
255/55-15	H66	1042		1142			
255/60-15	H70	1042	TC-343DC	1142			1553
255/65-15	H70	1042	TC-343DC	1142			
255/70-15	H70	2019	TC-735DC	1146			1555, 2517
255/75-15	H74	2029					2321, 2521

(Continued on next page)

PASSENGER FIT CHART**Guide only, please check - Actual fit and/or clearance can vary.**

Tire Size	Tire Sock	Ladder Cable	Diagonal Cable 300/700	Type "PL" 1100	Car Chain 1200	V-Bar 1800	Diamond 1500, 2300, 2500
15"	Pg. 24, 26	Pg. 24, 26	Pg. 24, 26	Pg. 25	Pg. 25	Pg. 25	Pg. 25, 27
		Class (S)	Class (S)	Class (S)	Class (U)	Class (U)	Class (S)
265/50-15	H66	1042	TC-339DC	1142			1547
265/60-15	H70	1042	TC-343DC	1142			
265/70-15	H74	3010	TC-735DC				2323, 2517
265/75-15	H74	3010	TC-741DC				
275/50-15	H66	1042	TC-339DC	1142			1555
275/60-15	H70	2019	TC-735DC	1146			1555, 2517
285/40-15	H62	1038	TC-331DC	1138			
285/70-15	H74						
295/50-15	H66	2019	TC-339DC	1146			
325/60-15	H74						

Tire Size	Tire Sock	Ladder Cable	Diagonal Cable 300/700	Type "PL" 1100	Car Chain 1200	V-Bar 1800	Diamond 1500, 2300, 2500
16"	Pg. 24, 26	Pg. 24, 26	Pg. 24, 26	Pg. 25	Pg. 25	Pg. 25	Pg. 25
		Class (S)	Class (S)	Class (S)	Class (U)	Class (U)	Class (S)
165/65-16	H62						
165/75-16	H66						1530
175/50-16	H58						
175/55-16	H62	1026	TC-319DC	1126			
175/60-16	H62	1026		1122			
175/70-16	H66						
175/75-16	H66	1022	TC-331DC	1122			1540
175/80-16	H70						
185/50-16	H58						
185/55-16	H62	1026	TC-323DC	1126			
185/60-16	H62			1122			
185/65-16	H66	1030	TC-329DC				
185/75-16	H66						
195/40-16	H58						
195/45-16	H58	1026					
195/50-16	H62	1026	TC-323DC	1126			1530
195/55-16	H62	1030	TC-327DC	1130			
195/60-16	H66	1030	TC-329DC	1130			1535
195/65-16	H66	1030	TC-329DC	1130			
195/75-16	H70	1038		1138			1550
195/85-16	H70						
205/40-16	H58	1030	TC-323DC	1130			1525
205/45-16	H58	1026	TC-323DC	1126			1525
205/50-16	H62	1034	TC-327DC	1134	1230	1830	1535
205/55-16	H62	1034	TC-331DC	1134	1230	1830	1540
205/60-16	H66	1034	TC-331DC	1138	1240	1840	1540
205/65-16	H66	1038	TC-335DC	1138	1254	1854	1545
205/70-16	H70	1038	TC-335DC	1138			
205/75-16	H70	2016					1547
205/80-16	H70	2016					
215/40-16	H58	1026	TC-323DC				
215/45-16	H62	1034	TC-323DC	1130			1535
215/50-16	H62	1034	TC-331DC	1134			
215/55-16	H66	1032	TC-331DC	1134			1540
215/60-16	H66	1034	TC-335DC	1138	1254	1854	1545

(Continued on next page)

PASSENGER FIT CHART

Guide only, please check - Actual fit and/or clearance can vary.

Tire Size	Tire Sock	Ladder Cable	Diagonal Cable 300/700	Type "PL" 1100	Car Chain 1200	V-Bar 1800	Diamond 1500, 2300, 2500
16"	Pg. 24, 26	Pg. 24, 26	Pg. 24, 26	Pg. 25	Pg. 25	Pg. 25,29	Pg. 25, 27
		Class (S)	Class (S)	Class (S)	Class (U)	Class (U)	Class (S)
215/65-16	H70	1038	TC-335DC	1138	1254	1854	1550
215/70-16	H70	1038	TC-339DC	1138	1254	1854	1550
215/75-16	H70	1042		1142			1555
215/85-16	H74	2019	TC-729DC				2317, 2517
225/45-16	H62	1034	TC-323DC	1134			1540
225/50-16	H62	1034	TC-331DC	1134	1240	1840	1545
225/55-16	H66	1038	TC-335DC	1138	1254	1854	1550
225/60-16	H66	1038	TC-339DC	1138	1254	1854	1550
225/65-16	H70	1038	TC-343DC	1138			1547
225/70-16	H70	2019	TC-343DC	1146			1555
225/75-16	H70	1042	TC-729DC	1142			2318, 2519
235/50-16	H66	1038	TC-335DC	1134			1545
235/55-16	H66	1038	TC-339DC	1138			
235/60-16	H70	1042	TC-339DC	1142			1553
235/65-16	H70	1042	TC-343DC	1142			1555
235/70-16	H70	2029	TC-729DC				2319, 2518
235/75-16	H74	2019	TC-735DC				2319
235/85-16	H74	2021	TC-741DC				2321, 2521
245/45-16	H62	1038	TC-331DC	1138			
245/50-16	H66	1038	TC-339DC	1138			1555
245/55-16	H66	1038	TC-339DC	1138			1553
245/60-16	H70	1042	TC-343DC	1142			
245/70-16	H74	2019	TC-735DC				2319, 2518
245/75-16	H72	2029	TC-741DC				2323, 2524
255/35-16	H58						
255/50-16	H66	1042	TC-343DC	1142			1555
255/55-16	H70	1042	TC-343DC	1142			1555
255/65-16	H70	1042	TC-735DC	1142			2319, 2517
255/70-16	H74	2029	TC-735DC				2324, 2524
255/75-16	H74	2016					
265/50-16	H66	1042	TC-343DC	1142		2829	
265/60-16	H70	2029	TC-729DC				
265/65-16	H74		TC-735DC				
265/70-16	H74	3010	TC-741DC				2324, 2524
265/75-16	H74	3010	TC-741DC				2326, 2526
275/70-16	H74	2028	TC-747DC				2324
285/65-16	H74	3010					2326

Tire Size	Tire Sock	Ladder Cable	Diagonal Cable 300/700	Type "PL" 1100	Car Chain 1200	V-Bar 1800	Diamond 1500, 2300, 2500
17" - 17.5"	Pg. 24	Pg. 24	Pg. 24	Pg. 25	Pg. 25	Pg. 25	Pg. 25, 27
		Class (S)	Class (S)	Class (S)	Class (U)	Class (U)	Class (S)
175/55-17	H62						
185/60-17	H66						
185/65-17	H66						
185/70-17	H70						
195/40-17	H58						

(Continued on next page)

PASSENGER FIT CHART

Guide only, please check - Actual fit and/or clearance can vary.

Tire Size	Tire Sock	Ladder Cable	Diagonal Cable 300/700	Type "PL" 1100	Car Chain 1200	V-Bar 1800	Diamond 1500, 2300, 2500
	Pg. 24, 26	Pg. 24, 26	Pg. 24, 26	Pg. 25	Pg. 25	Pg. 25	Pg. 25, 27
17" - 17.5"		Class (S)	Class (S)	Class (S)	Class (U)	Class (U)	Class (S)
195/45-17	H62						
195/75-17	H70						
205/40-17	H62	1026	TC-323DC	1126			
205/45-17	H62	1030	TC-327DC	1130			
205/50-17	H66	1038	TC-331DC	1138			1540
205/55-17	H66	1034	TC-329DC	1134			
205/75-17	H70						
215/35-17	H58						
215/40-17	H62	1030	TC-327DC	1130			
215/45-17	H62	1034	TC-331DC	1134			1540
215/50-17	H66	1038	TC-331DC	1138	1240	1840	1547
215/55-17	H66	1038	TC-335DC	1138			1547
215/60-17	H70	1042	TC-339DC	1138			1553
215/65-17	H70	1042	TC-339DC	1142			1553
225/35-17	H58						
225/40-17	H62	1030					
225/45-17	H62	1034	TC-331DC	1134			
225/50-17	H66	1038	TC-335DC	1138			1550
225/55-17	H66	1038	TC-339DC	1138			1553
225/60-17	H70	1042	TC-343DC	1138			1553
225/65-17	H70	1042	TC-343DC	1142			1555
225/70-17	H74		TC-729DC				
235/40-17	H62	1034	TC-331DC	1134			1540
235/45-17	H66	1038	TC-339DC	1138			
235/50-17	H66	1038	TC-339DC	1138			1550
235/55-17	H70	1042	TC-343DC	1142			1553
235/60-17	H70	1042	TC-343DC	1146			1555
235/65-17	H70	2019	TC-729DC	1146			1555, 2517
235/70-17	H74	2019	TC-735DC	1146			2317
245/35-17	H62	1034					
245/40-17	H62	1038	TC-331DC	1138			1547
245/45-17	H66	1038	TC-339DC	1138			1547
245/50-17	H66	1038	TC-339DC	1138			1553
245/55-17	H70	2029	TC-339DC				
245/65-17	H72	2019	TC-735DC	1146			2317
255/40-17	H62	1038	TC-339DC	1138			
255/45-17	H66	1042	TC-339DC	1142			1553
255/65-17	H74	2029					2323
265/40-17	H66		TC-339DC				
265/55-17	H70		TC-735DC				
265/65-17	H74	3010	TC-747DC				2324, 2526
265/70-17	H74	2028	TC-747DC				2326, 2526
275/35-17	H62						
275/40-17	H66	1042	TC-343DC	1142			
275/55-17	H70	2019	TC-741DC	1146			2323
275/60-17	H74	3010	TC-741DC				2324
275/65-17	H74	3010	TC-747DC				2326, 2526
285/40-17	H66	2019	TC-339DC	1146			
205/75-17.5	H74		TC-343DC				
215/75-17.5	H74	2021	TC-729DC				

PASSENGER FIT CHART

(Continued on next page)

Guide only, please check - Actual fit and/or clearance can vary.

Tire Size	Tire Sock	Ladder Cable	Diagonal Cable 300/700	Type "PL" 1100	Car Chain 1200	V-Bar 1800	Diamond 1500, 2300, 2500
17" - 17.5"	Pg. 24, 26	Pg. 26	Pg. 26	Pg. 25	Pg. 25	Pg. 25	Pg. 27
		Class (S)	Class (S)	Class (S)	Class (U)	Class (U)	Class (S)
235/75-17.5	H74	3010	TC-741DC				
245/75-17.5	H74	3010	TC-741DC				2321, 2524
245/70-17.5	H74	3010	TC-741DC				
265/70-17.5	H78						
195/40-17	H58						

Tire Size	Tire Sock	Ladder Cable	Diagonal Cable 300/700	Type "PL" 1100	Car Chain 1200	V-Bar 1800	Diamond 1500, 2300, 2500
18"	Pg. 24, 26	Pg. 24, 26	Pg. 24, 26	Pg. 25	Pg. 25	Pg. 25	Pg. 25, 27
		Class (S)	Class (S)	Class (S)	Class (U)	Class (U)	Class (S)
205/40-18	H62	1030	TC-327DC				
215/35-18	H62	1030					
215/40-18	H62	1038	TC-331DC	1138			1547
215/45-18	H66	1038	TC-331DC	1138			1547
215/50-18	H66						
215/55-18	H70	1038	TC-339DC	1138			1553
225/30-18	H62						
225/35-18	H62						
225/40-18	H66	1038	TC-339DC	1138			1547
225/45-18	H66	1038	TC-331DC	1138			1550
225/50-18	H66	1038	TC-339DC	1138			1553
225/55-18	H70	1042	TC-339DC	1142			1555
225/60-18	H70	2019	TC-729DC	1146			1555
225/65-18	H74	2019	TC-735DC	1146			2317, 2517
235/35-18	H62						
235/40-18	H66	1038	TC-339DC	1138			
235/45-18	H66	1038	TC-339DC	1138			1553
235/50-18	H70	2019	TC-343DC	1146			2318
235/55-18	H70	2019	TC-729DC	1146			1555
235/60-18	H70	2019	TC-729DC	1146			2319
235/65-18	H74	2019	TC-735DC	1146			2323
245/35-18	H62	1038	TC-331DC				
245/40-18	H66	1038	TC-339DC	1138			
245/45-18	H66	1042	TC-343DC	1142			
245/50-18	H70	1042	TC-343DC	1146			2318
245/60-18	H74	3010	TC-735DC				2323
255/30-18	H62						
255/35-18	H62	1038	TC-335DC				
255/40-18	H66	1038	TC-343DC	1138			
255/45-18	H70	1042	TC-343DC	1142			
255/50-18	H70	1042	TC-343DC				2319
255/55-18	H70	2019	TC-735DC	1146			2317
255/60-18	H74	2029	TC-741DC				2324
265/35-18	H66	1042	TC-339DC	1142			
265/40-18	H66	1042	TC-343DC	1142			1553
275/35-18	H66	2019	TC-343DC	1146			
275/40-18	H66	2019	TC-343DC	1146			
275/45-18	H70	2019		1146			
275/60-18	H74		TC-747DC				2326
285/35-18	H66	2019	TC-339DC	1146			

(Continued on next page)

PASSENGER FIT CHART**Guide only, please check - Actual fit and/or clearance can vary.**

Tire Size	Tire Sock	Ladder Cable	Diagonal Cable 300/700	Type "PL" 1100	Car Chain 1200	V-Bar 1800	Diamond 1500, 2300, 2500
18"	Pg. 26	Pg. 26	Pg. 26	Pg. 25	Pg. 25	Pg. 25	Pg. 27
		Class (S)	Class (S)	Class (S)	Class (U)	Class (U)	Class (S)
285/50-18	H70						
285/55-18	H74						
285/60-18	H74	3027	TC-751DC				2327

Tire Size	Tire Sock	Ladder Cable 1000	Diagonal Cable 300/700	Type "PL" 1100	Car Chain 1200	V-Bar 1800	Diamond 1500, 2300, 2500
19"	Pg. 24, 26	Pg. 24, 26	Pg. 24, 26	Pg. 25	Pg. 25	Pg. 25	Pg. 25, 27
		Class (S)	Class (S)	Class (S)	Class (U)	Class (U)	Class (S)
215/35-19	H62	1034	TC-327DC	1134			
225/35-19	H66	1038	TC-323DC	1138			1555
225/40-19	H66	1038	TC-339DC				
225/45-19	H70	1038	TC-339DC				
225/55-19	H70	2019	TC-729DC				2317
235/35-19	H66	1038	TC-339DC	1138			
235/40-19	H66	1038	TC-339DC				
235/45-19	H70	1042	TC-343DC	1142			2318
235/50-19	H70		TC-729DC				2317
235/55-19	H70	2019	TC-729DC	1146			2317
245/35-19	H66	1042	TC-339DC	1142			
245/40-19	H66	1042	TC-339DC	1142			1553
245/45-19	H70	1042	TC-343DC				1555
255/30-19	H62	1038	TC-335DC				
255/35-19	H66	1042	TC-343DC	1142			
255/40-19	H70	1042	TC-343DC	1142			
255/45-19	H70	1042					2319
255/50-19	H70	2029	TC-735DC				2323
265/30-19	H66						
265/35-19	H66		TC-339DC				
265/50-19	H74	3010	TC-741DC				2324
275/30-19	H66		TC-343DC				
275/35-19	H66	2019		1146			1555
275/40-19	H70	2019	TC-735DC	1146			
275/45-19	H70	3010	TC-741DC				
275/55-19	H74	2019	TC-747DC	1146			2326
285/35-19	H66	2019	TC-343DC	1146			
285/40-19	H70		TC-343DC				
285/45-19	H70	3027					

PASSENGER FIT CHART

Guide only, please check - Actual fit and/or clearance can vary.

Tire Size	Tire Sock	Ladder Cable	Diagonal Cable 300/700	Type "PL" 1100	Car Chain 1200	V-Bar 1800	Diamond 1500, 2300, 2500
20"	Pg. 24, 26	Pg. 24, 26	Pg. 24, 26	Pg. 25	Pg. 25	Pg. 25	Pg. 25, 27
		Class (S)	Class (S)	Class (S)	Class (U)	Class (U)	Class (S)
245/40-20	H70	2019	TC-343DC	1146			1555
245/45-20	H70	2029	TC-729DC				
255/35-20	H70	1042	TC-343DC	1142			
255/40-20	H70	1042					
255/45-20	H70	2029	TC-735DC				
255/50-20	H74	3010	TC-741DC				2324
255/55-20	H74	3010	TC-747DC				2326
265/35-20	H70	2019	TC-343DC	1146			1555
275/35-20	H70	2019		1146			
275/40-20	H70	3010	TC-735DC				
275/45-20	H74	3010	TC-741DC				2324
285/35-20	H70		TC-735DC				
295/35/-20	H70		TC-735DC				
295/40-20	H70	3010	TC-735DC				
295/45-20	H74	2028					
315/35-20	H70						
305/40-20	H74						

Tire Size	Tire Sock	Ladder Cable	Diagonal Cable 300/700	Type "PL" 1100	Car Chain 1200	V-Bar 1800	Diamond 1500, 2300, 2500
21" - 22"	Pg. 24, 26	Pg. 24	Pg. 26	Pg. 25	Pg. 25	Pg. 25	Pg. 27
		Class (S)	Class (S)	Class (S)	Class (U)	Class (U)	Class (S)
245/35-21	H70						
245/40-21	H70	1046					
255/40-21	H70	1046					
255/50-21	H74		TC-747DC				
265/35-21	H70						
275/45-21	H74						2326
275/50-21	H74						
285/35-21	H70						
295/35-21	H70		TC-735DC				
285/35-22	H74						
295/30-22	H70						

(Continued on next page)

LIGHT TRUCK FIT CHART

Guide only, please check - Actual fit and/or clearance can vary.

*1 = CAM AND NON-CAM AVAILABLE

*2 = STUDED AVAILABLE

*3 = TWISTED SQUARE LINK AVAILABLE

Tire Size	Tire Sock	Ladder Cable	Diagonal Cable 300/700	Light Weight Diamond	HD Diamond	Regular Single *1 *2 *3	Regular Duals *1 *2 *3	V-Bar Single *1	Square Link Single *1	Mud Service Single *1
14"	Pg. 24, 26	Pg. 24, 26	Pg. 24, 26	Pg. 25, 27	Pg. 27	Pg. 28	Pg. 28	Pg. 29	Pg. 30	Pg. 31
195/75-14	H66	1030	TC-329DC	1535		2209	4209	2809		
215/75-14	H66	2016		1545		2216	4217	2816	2216SCAM	
225/60-14	H62	1030	TC-327DC	1540		2209	4209	2809		
27x8.50-14		2016		1545		2216	4217	2816	2216SCAM	
27x9.50-14		2016				2216	4217	2816	2216SCAM	
29x9.50-14		2016				2216	4217	2816	2216SCAM	
195/75-15	H66		TC-335DC			2211		2811		
215/75-15	H70	2016		1550		2216	4217	2816	2219SCAM	2433
225/50-15	H62	1030	TC-327DC			2209	4209	2809		
225/70-15	H70	2016		1553		2216	4217	2816	2216SCAM	
225/70-16	H70	2019		1555		2219	4219	2819	2219SCAM	2435
225/75-15	H70	2016		1553		2216	4217	2816	2216SCAM	2435
235/70-15	H70	2016		1555		2216	4217	2816	2216SCAM	
235/75-15	H70	2019	TC-729DC	2319	2519	2219	4219	2819	2219SCAM	2435
245/70-15	H70	2029		2318		2229		2829	2229SCAM	2437
245/75-15	H74	2021	TC-729DC			2221	4221	2821	2221SCAM	2437
245/85-15	H74	2028		2324		2228	4231	2828	2228SCAM	2441
255/65-15	H70	2029				2229		2829	2229SCAM	2437
255/70-15	H70	2029		2319	2517	2229		2829	2229SCAM	2437
255/75-15	H74	2028		2321	2521	2228	4231	2828	2228SCAM	2439
255/80-15	H74									
265/70-15	H74	2021	TC-735DC	2317	2517	2221	4221	2821	2221SCAM	2437
265/75-15	H74	2021	741DC	2321		2221	4221	2821	2221SCAM	2437
275/60-15	H70	2029		2319	2517	2229		2829	2229SCAM	2437
27x9.50-15	H66	2029				2229		2829	2229SCAM	
285/70-15	H74	2019				2219	4219	2819	2219SCAM	
28x8.50-15	H70					2211	4211	2811		
29x9.50-15	H74	3010	729DC			3210		3810	3210SCAM	2437
305/50-15	H70	2016				2216	4217	2816	2216SCAM	
305/75-15	H78	3029				3229		3829	3229SCAM	3429
30x9.50-15	H72	3010	735DC	2319	2517	3210		3810	3210SCAM	2437
315/70-15	H78	3029				3229		3829		
31x10.50-15	H74	3027	741DC	2324	2524	3227		3827	3227SCAM	3427
31x11.50-15	H74	3027	747DC	2324		3227		3827	3227SCAM	3427
31x12.50-15	H74	3029				3229		3829	3229SCAM	3429
31x9.50-15	H74	3027			2518	3227		3827	3227SCAM	2437
325/60-15	H74	3029				3229		3829	3229SCAM	3429
32x11.50-15	H74	3029		2326	2526	3229		3829	3229SCAM	3429
32x12.50-15	H74	3029				3229		3829	3229SCAM	3429
32x9.50-15	H78	3027				3227		3827	3227SCAM	3427
33x10.50-15	H78	3029	751DC	2327		3229		3829	3229SCAM	3429
33x12.50-15	H78	3029				3229		3829	3229SCAM	3429
33x14.50-15	H78			2337		3231		3831	3231SCAM	3431
33x9.50-15	H78	3010		2326	2526	3210		3810	3210SCAM	2439
355/65-15	H78					3259		3859	3259SCAM	

(Continued on next page)

LIGHT TRUCK FIT CHART

Guide only, please check - Actual fit and/or clearance can vary.

*1 = CAM AND NON-CAM AVAILABLE

*2 = STUDED AVAILABLE

*3 = TWISTED SQUARE LINK AVAILABLE

Tire Size	Tire Sock	Ladder Cable	Diagonal Cable 300/700	Light Weight Diamond	HD Diamond	Regular Single *1 *2 *3	Regular Duals *1 *2 *3	V-Bar Single *1	Square Link Single *1	Mud Service Single *1
15" - 16"	Pg. 24, 26	Pg. 26	Pg. 26	Pg. 25, 27	Pg. 27	Pg. 28	Pg. 28	Pg. 29	Pg. 30	Pg. 31
35x10.50-15	H90					3227		3827	3227SCAM	3427
35x12.50-15	H90				2536	3235		3835	3235SCAM	3435
35x13.50-15	H88				2536	3235		3835	3235SCAM	3435
35x14.50-15	H88			2337		3235		3835	3235SCAM	3435
35x14-15	H88			2337		3235		3835	3235SCAM	3435
36x12.50-15	H90					3235		3835	3235SCAM	3435
36x13.50-15	H90					3265		3865	3265SCAM	
36x14.50-15	H90					3251		3851	3251SCAM	
36x14-15	H90					3251		3851	3251SCAM	
37x12.50-15	H94					3235		3835	3235SCAM	2445
37x14.50-15	H94					3251		3851	3251SCAM	
38.5x16-15	H94					3249		3849	3249SCAM	
38x12.50-15	H94					3259		3859	3259SCAM	
38x14.50-15	H94					3259		3859	3259SCAM	
38x15.50-15	H94					3249		3849	3249SCAM	
38x15-15	H94					3235		3835	3235SCAM	3435
42x15-15	H100					3267		3867	3267SCAM	
44x18.50-15	H104					3269		3869	3269SCAM	
205/75-16	H70	2016				2216	4217	2816	2216SCAM	2433
205/80-16	H70	2029				2229		2829	2229SCAM	
215/70-16	H70	2016		1553		2216	4217	2816	2216SCAM	
215/75-16	H70	2016				2216	4217	2816	2216SCAM	
215/85-16	H74	2019	729DC	2317	2517	2219	4219	2819	2219SCAM	2435
225/50-16	H62	1042				2209	4209	2809		
225/75-16	H70	2019	729DC	2319	2519	2219	4219	2819	2219SCAM	2435
225/85-16	H74	2021				2221	4221	2821	2221SCAM	2437
235/60-16	H70	1042	339DC	1553		2211	4211	2811		
235/65-16	H70	2029		2318	2519	2229		2829	2229SCAM	
235/70-16	H70	2029	729DC	2319		2229		2829	2229SCAM	2435
235/75-16	H74	2019	735DC	2319	2519	2219	4219	2819	2219SCAM	2435
235/80-16	H74	2019		2319		2219	4219	2819	2219SCAM	
235/85-16	H74	2021	741DC	2321	2521	2221	4221	2821	2221SCAM	2437
245/65-16	H70									2437
245/70-16	H74	2029		2319	2518	2229		2829	2229SCAM	2435
245/75-16	H74	2021	741DC	2323	2524	2221	4221	2821	2221SCAM	2437
245/85-16	H78	2028				2228	4231	2828	2228SCAM	2439
255/60-16	H70	2029		2319		2229		2829	2229SCAM	
255/65-16	H70	2029		2319	2517	2229		2829	2229SCAM	2437
255/70-16	H74	2021		2323	2524	2221	4221	2821	2221SCAM	2437
255/75-16	H74	2028				2228	4231	2828	2228SCAM	2439
255/85-16	H78	2028		2326	2526	2228	4231	2828	2228SCAM	2439
265/55-16	H70	2029				2229		2829	2229SCAM	
265/65-16	H74	2029	735DC			2229		2829	2229SCAM	2437

(Continued on next page)

LIGHT TRUCK FIT CHART

Guide only, please check - Actual fit and/or clearance can vary.

*1 = CAM AND NON-CAM AVAILABLE

*2 = STUDED AVAILABLE

*3 = TWISTED SQUARE LINK AVAILABLE

Tire Size	Tire Sock	Ladder Cable	Diagonal Cable 300/700	Light Weight Diamond	HD Diamond	Regular Single *1 *2 *3	Regular Duals *1 *2 *3	V-Bar Single *1	Square Link Single *3	Mud Service Single *1
16"-16.5"	Pg. 24, 26	Pg. 26	Pg. 26	Pg. 27	Pg. 27	Pg. 28	Pg. 28	Pg. 29	Pg. 30	Pg. 31
265/70-16	H74	2028	741DC	2324	2524	2228	4231	2828	2228SCAM	2439
265/75-16	H74	2028	747DC	2326	2526	2228	4231	2828	2228SCAM	2439
265/85-16	H80	2028				2228	4231	2828	2228SCAM	2439
275/55-16	H70	2029				2229		2829	2229SCAM	
275/65-16	H74	3027	741DC			3227		3827	3227SCAM	3427
275/70-16	H74		747DC	2324		3229		3829	3229SCAM	2440
275/75-16	H78	3029	747DC	2327		3229		3829	3229SCAM	3429
285/60-16	H74					3227	4231	3827	3227SCAM	2439
285/70-16	H74		751DC			3229		3829	3229SCAM	2440
285/75-16	H78				2533	3229		3829	3229SCAM	2440
295/65-16	H74	3029				3229		3829	3229SCAM	3429
295/75-16	H80	3029				3229		3829	3229SCAM	2440
29x9.50-16		3010				3210		3810	3210SCAM	2439
305/70-16	H78			2335	2533	3231		3831	3231SCAM	2440
305/85-16	H90					3259		3859	3259SCAM	
315/70-16	H78					3231		3831	3231SCAM	2440
315/75-16	H88	3029		2337	2536	3231		3831	3231SCAM	2441
31x16-16	H74					3259		3859	3259SCAM	
325/80-16	H94					3251		3851	3251SCAM	
33x13.50-16	H78			2335	2533	3235		3835	3235SCAM	3435
35x13.50-16	H90			2335		3235		3835	3235SCAM	3435
36.5x14-16	H90					3235		3835	3235SCAM	3435
365/65-16	H88	3029			2539					
38x15-16						3265		3865	3265SCAM	
7.50-16		2021	741DC	2324	2524	2221	4221	2821	2221SCAM	2437
9.00-16	H90					2237		2837	2237SCAM	
30x9.50-16.5	H74	3010				3210		3810	3210SCAM	2435
31x10.50-16.5	H74	3027	741DC		2519	3227		3827	3227SCAM	3427
31x11.50-16.5	H74	3027				3227		3827	3227SCAM	3427
32x11.50-16.5	H74	3027				3227		3827	3227SCAM	3427
32x12.50-16.5	H74	3029				3229		3829	3229SCAM	3429
33x12.50-16.5	H78	3029				3229		3829	3229SCAM	3429
35x12.50-16.5	H90			2337	2537	3231		3831	3231SCAM	2441
35x14-16.5	H90					3235		3835	3235SCAM	3435
36x12.50-16.5	H90					3235		3835	3235SCAM	3435
36x14.50-16.5	H90					3249		3849	3249SCAM	
36x14-16.5	H90					3235		3835	3235SCAM	3435
37x12.50-16.5	H94					3235		3835	3235SCAM	3435
37x14.50-16.5	H94					3251		3851	3251SCAM	
38.5x15-16.5	H94					3235		3835	3235SCAM	3435
38.5x16-16.5	H94					3249		3849	3249SCAM	
38x15.5-16.5	H94					3235		3835	3235SCAM	3435
39.5x15-16.5	H94					3251		3851	3251SCAM	
40x17-16.5	H96					3251		3851	3251SCAM	
44x18.5-16.5	H108					3269		3869	3269SCAM	
9.50-16.5		2021	735DC	2317	2517	2221	4221	2821	2221SCAM	2437

(Continued on next page)

LIGHT TRUCK FIT CHART

Guide only, please check - Actual fit and/or clearance can vary.

*1 = CAM AND NON-CAM AVAILABLE

*2 = STUDED AVAILABLE

*3 = TWISTED SQUARE LINK AVAILABLE

Tire Size	Tire Sock	Ladder Cable	Diagonal Cable 300/700	Light Weight Diamond	HD Diamond	Regular Single *1 *2 *3	Regular Duals *1 *2 *3	V-Bar Single *1	Square Link Single *3	Mud Service Single *1
17"-17.5"	Pg. 24, 26	Pg. 24, 26	Pg. 24, 26	Pg. 27	Pg. 27	Pg. 28	Pg. 28	Pg. 29	Pg. 30	Pg. 31
225/75-17	H74	2019	TC-729DC	2323		2219	4219	2819	2219SCAM	
235/50-17	H66	1042	TC-339DC			1142				
235/60-17	H70	3010	TC-343DC	2318		3210		3810	3210SCAM	
235/65-17	H70	2019	TC-729DC	2319	2517	2229	4211	2811		
235/70-17	H74	2019	TC-735DC	2317		2219	4219	2819	2219SCAM	
235/75-17	H74	3010	TC-735DC	2323		3210		3810	3210SCAM	
235/80-17	H74	2021	TC-747DC	2321	2524	2221	4221	2821	2221SCAM	2437
235/85-17	H78									
245/45-17	H66	1042				1138				
245/60-17	H70	2029	TC-735DC			2229		2829	2229SCAM	
245/65-17	H74	3010	TC-735DC	2317		3210		3810	3210SCAM	2439
245/70-17	H74	3010	TC-741DC	2323	2524	3210		3810	3210SCAM	2439
245/75-17	H74	2028	TC-741DC	2326	2526	2228	4231	2828	2228SCAM	2439
255/55-17	H70	2019	TC-343DC			2219	4219	2819	2219SCAM	
255/60-17	H70	3010	TC-735DC	2317	2526	3210		3810	3210SCAM	2439
255/65-17	H74	2028		2323		2228	4231	2828	2228SCAM	2439
255/70-17	H74	2028	TC-747DC	2321	2524	2228	4231	2828	2228SCAM	
255/75-17	H74	2028	TC-751DC	2326	2526	2228	4231	2828	2228SCAM	2439
255/80-17	H78					2237	4222	2837	2237SCAM	
255/85-17	H80									
265/55-17	H70	3010	TC-735DC			3210		3810	3210SCAM	
265/65-17	H74	3010	TC-747DC	2324	2526	3210		3810	3210SCAM	2439
265/70-17	H74	2028	TC-747DC	2326	2526	2228	4231	2828	2228SCAM	2439
265/75-17	H78	2028	TC-751DC	2326	2526	2228	4231	2828	2228SCAM	2439
275/50-17	H70	3010				3210		3810	3210SCAM	2439
275/55-17	H70	3010	TC-735DC	2323		3210		3810	3210SCAM	
275/60-17	H74	3027	TC-741DC	2324		3227		3827	3227SCAM	3427
275/70-17	H78	2028	TC-747DC			2228	4231	2828	2228SCAM	2439
285/60-17	H74	2028		2326		2228	4231	2828	2228SCAM	2439
285/70-17	H78	3029		2327	2533	3229		3829	3229SCAM	2440
285/75-17	H78	3029		2335		3229		3829	3229SCAM	
295/70-17	H78	3029			2536	3229		3829	3229SCAM	3429
305/60-17	H74	3035				3235		3835	3235SCAM	3435
305/65-17	H78	3029		2335	2536	3229		3829	3229SCAM	3429
305/70-17	H78	3029			2536	3229		3829	3229SCAM	3429
315/70-17	H88	3031			2536	3231		3831	3231SCAM	3431
315/75-17	H90					3231		3831	3231SCAM	3431
33x12.50-17	H78	3029		2335		3229		3829	3229SCAM	3429
35x12.50-17	H90			2337	2537	3231		3831	3231SCAM	3431
37x12.50-17	H94					3235		3835	3235SCAM	3435
37x13.50-17	H94					3251		3851	3251SCAM	
215/70-17.5		2019				2219	4219	2819	2219SCAM	2435
215/75-17.5	H74	2029	TC-729DC		2517	2229		2829	2229SCAM	2437
225/70-17.5	H74	2014				2214	4214	2814	2214SCAM	2439
235/70-17.5	H74		TC-735DC			2221		2821	2221SCAM	
235/75-17.5	H74	2028	TC-741DC		2521	2228	4231	2828	2228SCAM	2439
245/70-17.5	H74	2028	TC-741DC			2228	4231	2828	2228SCAM	
265/70-17.5	H78									
275/70-17.5	H78	2028				2228	4228	2828	2228SCAM	
8-17.5	H78	2014				2214	4214	2814	2214SCAM	2439

(Continued on next page)

LIGHT TRUCK FIT CHART

Guide only, please check - Actual fit and/or clearance can vary.

*1 = CAM AND NON-CAM AVAILABLE

*2 = STUDED AVAILABLE

*3 = TWISTED SQUARE LINK AVAILABLE

Tire Size	Tire Sock	Ladder Cable	Diagonal Cable 300/700	Light Weight Diamond	HD Diamond	Regular Single *1 *2 *3	Regular Duals *1 *2 *3	V-Bar Single *1	Square Link Single *3	Mud Service Single *1
18"	Pg. 24, 26	Pg. 26	Pg. 24, 26	Pg. 25, 27	Pg. 27	Pg. 28	Pg. 28	Pg. 29	Pg. 30	Pg. 31
225/55-18	H70	2016	TC-339DC	1555		2229		2829	2229SCAM	
225/65-18	H74	2029	TC-735DC	2317	2517	2229		2829	2229SCAM	
235/60-18	H70	2029	TC-729DC	2319		2229		2829	2229SCAM	
235/65-18	H74	2029	TC-735DC	2321	2524	2229		2829	2229SCAM	
235/80-18	H78	2028				2228	4231	2828	2228SCAM	2439
245/55-18	H70	2029	TC-729DC	2319		2229		2829	2229SCAM	
245/60-18	H74	2029	TC-735DC	2317	2517	2229		2829	2229SCAM	
245/75-18	H78									
255/55-18	H70	2029	TC-735DC	2317		2229		2829	2229SCAM	2435
255/60-18	H74	3010	TC-741DC	2324		3210		3810	3210SCAM	2439
255/65-18	H74	3010	TC-747DC	2326		2229		2829	2229SCAM	
255/70-18	H74	2028	TC-747DC	2326		2228	4231	2828	2228SCAM	2439
265/60-18	H74	2028	TC-741DC	2321	2526	2228	4231	2828	2228SCAM	
265/65-18	H74	2028	TC-747DC	2326	2526	2228	4231	2828	2228SCAM	2439
265/70-18	H78	2028	TC-751DC	2327		2228	4231	2828	2228SCAM	2439
265/75-18	H78	3029				3229		3829	3229SCAM	3429
275/55-18	H74	3010		2324		3210		3810	3210SCAM	2439
275/60-18	H74	2028	TC-747DC	2326		2228	4231	2828	2228SCAM	2439
275/65-18	H74	2028	TC-751DC			2228	4231	2828	2228SCAM	2439
275/70-18	H78	3029			2533	3229		3829	3229SCAM	2440
275/75-18	H88	3029				3229		3829	3229SCAM	3429
285/50-18	H70	2028				2228	4231	2828	2228SCAM	2439
285/55-18	H74	3010				3210		3810	3210SCAM	2439
285/60-18	H74	2028	TC-751DC	2327		2228	4231	2828	2228SCAM	2439
285/65-18	H78	3029		2327	2533	3229		3829	3229SCAM	3429
285/70-18	H78	3031				3231		3831	3231SCAM	2440
285/75-18	H88				2536	3231		3831	3231SCAM	
295/45-18	H70	3010		2324		3210		3810	3210SCAM	2439
295/70-18	H88	3031				3231		3831	3231SCAM	2440
295/75-18	H90	3031				3231		3831	3231SCAM	2440
305/60-18	H78	3031			2536	3231		3831	3231SCAM	3431
305/65-18	H78	3029				3229		3829	3229SCAM	3429
305/70-18	H88	3031			2539	3231		3831	3231SCAM	3431
325/60-18	H78	3031		2337	2536	3231		3831	3231SCAM	3431
325/65-18	H88	3031				3231		3831	3231SCAM	3431
33x12.50x18						3229		3829	3229SCAM	3429
355/65-18	H90									
355/80-18	H98									
35x12.50-18	H88					3231		3831	3231SCAM	3431
365/70-18	H94									
37x13.50-18	H94					3251		3851	3251SCAM	
37x12.50-18	H94					3235		3835	3235SCAM	3435

(Continued on next page)

LIGHT TRUCK FIT CHART

Guide only, please check - Actual fit and/or clearance can vary.

*1 = CAM AND NON-CAM AVAILABLE

*2 = STUDED AVAILABLE

*3 = TWISTED SQUARE LINK AVAILABLE

Tire Size	Tire Sock	Ladder Cable	Diagonal Cable 300/700	Light Weight Diamond	HD Diamond	Regular Single *1 *2 *3	Regular Duals *1 *2 *3	V-Bar Single *1	Square Link Single *3	Mud Service Single *1
19"-24"	Pg. 24, 26	Pg. 26	Pg. 26	Pg. 27	Pg. 27	Pg. 28	Pg. 28	Pg. 29	Pg. 30	Pg. 31
225/55-19	H70	2019	TC-729DC	2317		2229		2829		
235/55-19	H70	2019	TC-729DC	2317		2219	4219	2819	2219SCAM	
245/55-19	H74	3010	TC-735DC	2324		3210		3810	3210SCAM	2439
255/50-19	H70	3010	TC-735DC	2323		3210		3810	3210SCAM	2439
255/55-19	H74	3010	TC-747DC	2324		3210		3810	3210SCAM	2439
255/60-19	H74	3010	TC-747DC							
275/45-19	H70	2029	TC-741DC			2229		2829	2229SCAM	
275/55-19	H74	2028	TC-747DC	2326		2228	4231	2828	2228SCAM	
285/45-19	H70	3010				3210		3810	3210SCAM	2439
295/70-19		3035				3235				
305/70-19	H90									
225/70-19.5	H74	2014	TC-741DC		2526	2214	4214	2814	2214SCAM	2437
245/70-19.5	H78	2028	TC-751DC	2326	2526	2228	4231	2828	2228SCAM	2439
265/70-19.5	H88	2039				2237	4222	2837	2237SCAM	
265/75-19.5	H90									
275/70-19.5	H88									
275/75-19.5	H90									
285/70-19.5	H90	2039				2239	4239	2839	2239SCAM	
305/70-19.5	H90	2039				2239	4239	2839	2239SCAM	
245/45-20	H70	2029				2229		2829	2229SCAM	
235/55-20	H74	2021	TC-735DC	2324		2221		2821	2221SCAM	
245/50-20	H74	3010	TC-729DC	2323		3210		3810	3210SCAM	2439
245/60-20				2323		2228	4228	2828	2228SCAM	
255/45-20	H70	2029	TC-735DC			2229		2829	2229SCAM	
255/50-20	H74	3010	TC-741DC	2324		3210		3810	3210SCAM	2439
255/55-20	H74		TC-747DC			2228		2828	2228SCAM	
255/60-20	H74	2028				2228	4231	2828	2228SCAM	
265/60-20	H78	3027				3227		3827	3227SCAM	3427
265/45-20	H74	3010	TC-741DC	2323		3210		3810	3210SCAM	2439
265/50-20	H74	3027	TC-747DC	2326		3227		3827	3227SCAM	3427
265/65-20	H78									
275/40-20	H70	3010	TC-741DC			3210		3810	3210SCAM	2439
275/45-20	H74	2028	TC-741DC	2324		2228	4231	2828	2228SCAM	2439
275/50-20	H74	2028	TC-747DC	2326		2228	4231	2828	2228SCAM	
275/55-20	H74	2028	TC-751DC	2327	2533	2228	4228	2828	2228SCAM	2440
275/60-20	H78	3029			2533	3229		3829	3229SCAM	3429
275/65-20	H78	3031		2335	2536	3231		3831	3231SCAM	3431
285/50-20	H74	2028	TC-751DC	2327		2228	4231	2828	2228SCAM	
285/60-20	H78	3029		2335		3229		3829	3229SCAM	3429
285/65-20	H88	3031				3231		3831	3231SCAM	3431
295/40-20	H70	2028	TC-735DC			2228	4231	2828	2228SCAM	2439
295/45-20	H74					3227		3827	3227SCAM	3427
295/55-20		3031				3231	4231	3831	3231SCAM	3431
295/60-20		3035				3235		3835	3235SCAM	3435
305/30-20	H70					3257			3257SCAM	
305/45-20	H74	3029				3229		3829	3229SCAM	3429
305/50-20	H74	3029		2335		3229		3829	3229SCAM	3429
305/55-20	H78	3031		2337	2536	3231		3831	3231SCAM	3431
305/60-20	H88									
325/50-20	H78	3031				3231		3831	3231SCAM	3431
325/60-20	H90	2039			2539	3235		3831	3235SCAM	3435
33x12.50-20	H78					3231		3831	3231SCAM	3431
355/60-20	H94					3251		3851	3251SCAM	
35x12.50-20	H90	2039		2335	2536	3235		3835	3235SCAM	3435

(Continued on next page)

LIGHT TRUCK FIT CHART

Guide only, please check - Actual fit and/or clearance can vary.

*1 = CAM AND NON-CAM AVAILABLE

*2 = STUDED AVAILABLE

*3 = TWISTED SQUARE LINK AVAILABLE

Tire Size	Tire Sock	Ladder Cable	Diagonal Cable 300/700	Light Weight Diamond	HD Diamond	Regular Single *1 *2 *3	Regular Duals *1 *2 *3	V-Bar Single *1	Square Link Single *3	Mud Service Single *1
19"-24"	Pp. 26-32	Pg. 26	Pg. 26	Pg. 27	Pg. 27	Pg. 28	Pg. 28	Pg. 29	Pg. 30	Pg. 31
35x13.50-20	H90					3235		3831	3231SCAM	3435
37x12.50-20	H94					3235		3835	3235SCAM	3435
37x13.50-20	H94					3251		3851	3251SCAM	
385/65-20	H96	3031				3231		3831	3231SCAM	3431
40x15.50-20	H96					3255		3855	3255SCAM	
265/40-22	H74	3010				3210		3810	3210SCAM	2439
275/45-22	H74	2028	TC-747DC			2228	4231	2828	2228SCAM	
285/35-22	H74	2028				2228	4231	2828	2228SCAM	
285/45-22	H78	2028	TC-751DC	2327	2533	3229		3829	3229SCAM	
305/40-22	H74	3029		2327		3229		3829	3229SCAM	3429
305/45-22	H78	3029		2335		3229		3829	3229SCAM	3429
325/40-22	H78	3029		2328		3229		3829	3229SCAM	3429
325/50-22	H88				2539	3235		3835	3235SCAM	3435
285/40-24	H78	3029				3229		3829	3229SCAM	3429
295/35-24	H78	3031								
295/40-24	H78	3031		2337	2536	3231		3831	3231SCAM	3431
305/35-24	H78	3031								

*1 = CAM AND NON-CAM AVAILABLE

*2 = STUDED AVAILABLE

*3 = TWISTED SQUARE LINK AVAILABLE

*4 = HD AVAILABLE

TRUCK CHAIN FIT CHART

Guide only, please check - Actual fit and/or clearance can vary.

Tire Size	Tire Sock	Ladder Cable	Diagonal Cable 700, 800 DC	Regular Single *1 *2 *3	Regular Duals *1 *2 *3	V-Bar Single *1	V-Bar Duals *1	Wide Base Duals *1	Mud Service Single *1	Long Life Alloy Single *1 *4	Square Link Single *1 *3	HD Link Single *1
19.5"-24.5"	Pg. 26, 32	Pg. 32	Pg. 26, 32	Pg. 33, 36	Pg. 33	Pg. 33	Pg. 33	Pg. 36	Pg. 35	Pg. 34	Pg. 36	Pg. 34
15-19.5		3065		3265							3265SCAM	3265SHD
16.5-19.5		3055		3255							3255SCAM	
18-19.5		3057		3257							3257SCAM	
225/70-19.5	H74	2014		2214	4214	2814	4814		2437	2214ACAM	2214SCAM	2214SHD
245/70-19.5	H78	2028		2228	4231	2828	4831		2439	2228ACAM	2228SCAM	2228SHD
265/70-19.5	H88	2037		2237	4237	2837	4837			2237ACAM	2237SCAM	2237SHD
265/75-19.5	H90	2037		2237	4237	2837	4837			2237ACAM	2237SCAM	2237SHD
275/70-19.5	H88	2037		2237	4237	2837	4837			2237ACAM	2237SCAM	2237SHD
285/70-19.5	H90	2039		2239	4239	2839	4839			2239ACAM	2239SCAM	2239SHD
305/70-19.5	H90	2039		2239	4239	2839	4839			2239ACAM	2239SCAM	2239SHD
445/65-19.5	H100			3271						3271ACAM	3271SCAM	
6.50-20				2233	4233	2833	4833	3259		2233ACAM	2233SCAM	2233SHD
7.00-20			TC-751DC	2233	4233	2833	4833	3265		2233ACAM	2233SCAM	2233SHD
7.50-20		2037		2237	4237	2837	4837	3267	2441	2237ACAM	2237SCAM	2237SHD
8.25-20	H94	2039		2239	4239	2839	4839	3269	2441	2239ACAM	2239SCAM	2239SHD
9.00-20	H98	2041	TC-881DC	2241	4241	2841	4841	3273	2445	2241ACAM	2241SCAM	2241SHD
10.00-20	H102	2045	TC-881DC	2245	4245	2845	4845	3275	2448	2245ACAM	2245SCAM	2245SHD
11.00-20			TC-887DC	2251	4251	2851	4851	3277	2452	2251ACAM	2251SCAM	
12.00-20	H106		TC-891DC	2255	4255	2855	4855	3255	2486	2255ACAM	2255SCAM	
13/80-20				2255	4255	2855	4855	3255	2448	2255ACAM	2255SCAM	
14/80-20				2257	4257	2857	4857	3255		2257ACAM	2257SCAM	
275/45-20	H74	2028		2228	4231	2828	4831	3227		2228ACAM	2228SCAM	2228SHD
285/50-20	H74	2028		2228	4231	2828	4831	3231		2228ACAM	2228SCAM	2228SHD
335/80-20	H98			3254						3254ACAM	3254SCAM	
365/80-20	H104	3055		3255						3255ACAM	3255SCAM	

(Continued on next page)

*1 = CAM AND NON-CAM AVAILABLE

*2 = STUDED AVAILABLE

*3 = TWISTED SQUARE LINK AVAILABLE

*4 = HD AVAILABLE

TRUCK CHAIN FIT CHART

Guide only, please check - Actual fit and/or clearance can vary.

Tire Size	Tire Sock	Ladder Cable	Diagonal Cable 700, 800 DC	Regular Single *1 *2 *3	Regular Duals *1 *2 *3	V-Bar Single *1	V-Bar Duals *1	Wide Base Duals *1	Mud Service Single *1	Long Life Alloy Single *1 *4	Square Link Single *1 *3	HD Link Single *1
19.5"-24.5"	Pg. 32	Pg. 32	Pg. 32	Pg. 33	Pg. 33	Pg. 33	Pg. 33	Pg. 36	Pg. 35	Pg. 34	Pg. 34	Pg. 34
395/85-20	H108			2612								
10.00-22	H96	2049	TC-887DC	2249	4249	2849	4849	3277	2452	2249ACAM	2249SCAM	2249SHD
11.00-22	H102		TC-891DC	2255	4255	2855	4855	3277	2452	2255ACAM	2255SCAM	
7-22.5			TC-751DC	2233	4233	2833	4833	3259	2439	2233ACAM	2233SCAM	2233SHD
8-22.5		2039		2237	4222	2837	4822	3267		2237ACAM	2237SCAM	2237SHD
9-22.5	H94	2039		2239	4239	2839	4839	3269	2441	2239ACAM	2239SCAM	2239SHD
10-22.5	H96	2041		2241	4241	2841	4841	3273	2445	2241ACAM	2241SCAM	2241SHD
11-22.5	H102	2045	TC-881DC	2245	4245	2845	4845	3275	2448	2245ACAM	2245SCAM	2245SHD
12.5-22.5	H106		TC-887DC	2255	4255	2855	4855	3277	2452	2255ACAM	2255SCAM	
12-22.5	H106	2049	TC-887DC	2251	4251	2851	4851	3277	2452	2251ACAM	2251SCAM	
13-22.5		3055	TC-891DC									
15-22.5		3055		3255							3255SCAM	
16.5-22.5		3071		3271						3271ACAM	3271SCAM	
18-22.5		3061		3261							3261SCAM	
225/70-22.5	H88			2233	4233	2833	4833			2233ACAM	2233SCAM	2233SHD
235/75-22.5	H92	2039		2239	4239	2839	4839			2239ACAM	2239SCAM	2239SHD
235/80-22.5	H94	2039		2239	4239	2839	4839	3269	2441	2239ACAM	2239SCAM	2239SHD
245/70-22.5	H92	2039		2239	4239	2839	4839	3269	2441	2239ACAM	2239SCAM	2239SHD
245/75-22.5	H94	2041		2241	4241	2841	4841		2441	2241ACAM	2241SCAM	2241SHD
255/60-22.5	H88	2037		2237	4237	2837	4837			2237ACAM	2237SCAM	2237SHD
255/70-22.5	H94	2039		2239	4239	2839	4839	3269	2441	2239ACAM	2239SCAM	2239SHD
255/75-22.5	H94	2039		2239	4239	2839	4839	3269	2441	2239ACAM	2239SCAM	2239SHD
255/80-22.5	H94	2039		2239	4239	2839	4839	3269	2441	2239ACAM	2239SCAM	2239SHD
265/70-22.5	H94	2041		2241	4241	2841	4841		2445	2241ACAM	2241SCAM	2241SHD
265/75-22.5	H94	2041		2241	4241	2841	4841		2445	2241ACAM	2241SCAM	2241SHD
275/75-22.5	H94	2039	TC-877DC	2239	4239	2839	4839			2239ACAM	2239SCAM	2239SHD
275/70-22.5	H94	2039		2239	4239	2839	4839		2445	2239ACAM	2239SCAM	2239SHD
275/80-22.5	H96	2045	TC-881DC	2245	4245	2845	4845		2445	2245ACAM	2245SCAM	2245SHD
275/85-22.5	H98	2047		2247	4247	2847	4847			2247ACAM	2247SCAM	2247SHD
285/75-22.5	H96	2047	TC-877DC	2247	4247	2847	4847		2448	2247ACAM	2247SCAM	2247SHD
285/80-22.5	H98		TC-881DC	2251	4251	2851	4851			2251ACAM	2251SCAM	
295/70-22.5	H94	2047	TC-877DC	2247	4247	2847	4847		2448	2247ACAM	2247SCAM	2247SHD
295/75-22.5	H96	2047	TC-881DC	2247	4247	2847	4847	3275	2448	2247ACAM	2247SCAM	2247SHD
295/80-22.5	H98			2251	4251	2851	4851		2448	2251ACAM	2251SCAM	
305/70-22.5	H96	2047	TC-881DC	2247	4247	2847	4847			2247ACAM	2247SCAM	2247SHD
305/85-22.5	H102			2251	4251	2851	4851			2251ACAM	2251SCAM	
315/70-22.5								3255		3255ACAM		
315/80-22.5	H100		TC-887DC	2255	4255	2855	4855	3277	2486	2255ACAM	2255SCAM	
365/70-22.5	H102	3055						3255		3255ACAM	3255SCAM	
365/80-22.5	H108	3055						3255		3255ACAM	3255SCAM	
385/65-22.5	H100	3055						3255		3255ACAM	3255SCAM	
425/55-22.5	H98	3071						3271		3271ACAM	3271SCAM	
425/65-22.5	H106	3071						3271		3271ACAM	3271SCAM	
445/50-22.5	H96	3069	TC-897DC	3269				3269		3269ACAM	3269SCAM	
445/55-22.5	H100	3069		3269				3269		3269ACAM	3269SCAM	
445/65-22.5	H108							3261		3261ACAM	3261SCAM	
455/50-22.5	H98	3069	TC-897DC	3269						3269ACAM	3269SCAM	
455/55-22.5	H100	3071						3271		3271ACAM	3271SCAM	
11.00-24			TC-891DC	2253	4253	2853	4853		2470	2253ACAM	2253SCAM	
11-24.5	H104	2049	TC-887DC	2249	4249	2849	4849	3277	2452	2249ACAM	2249SCAM	2249SHD
12.00-24				2257	4257	2857	4857			2257ACAM	2257SCAM	

(Continued on next page)

TRUCK CHAIN FIT CHART

Guide only, please check - Actual fit and/or clearance can vary.

*1 = CAM AND NON-CAM AVAILABLE
*2 = STUDED AVAILABLE
*3 = TWISTED SQUARE LINK AVAILABLE
*4 = HD AVAILABLE

Tire Size	Tire Sock	Ladder Cable	Diagonal Cable 700, 800 DC	Regular Single *1 *2 *3	Regular Duals *1 *2 *3	V-Bar Single *1	V-Bar Duals *1	Wide Base Duals *1	Mud Service Single *1	Long Life Alloy Single *1 *4	Square Link Single *1 *3	HD Link Single *1
19.5"-24.5"	Pg. 32	Pg. 32	Pg. 32	Pg. 33	Pg. 33	Pg. 33	Pg. 33	Pg. 36	Pg. 35	Pg. 34	Pg. 34	Pg. 34
12-24.5			TC-891DC	2255	4255	2855	4855	3255	2486	2255ACAM	2255SCAM	
275/80-24.5	H100	2047		2247	4247	2847	4847	3273	2452	2247ACAM	2247SCAM	2247SHD
285/75-24.5	H98	2049	TC-881DC	2249	4249	2849	4849	3275	2452	2249ACAM	2249SCAM	2249SHD
285/80-24.5	H100	2049	TC-881DC	2249	4249	2849	4849		2452	2249ACAM	2249SCAM	2249SHD
305/75-24.5	H102		TC-887DC	2255	4255	2855	4855	3277	2452	2255ACAM	2255SCAM	
315/75-24.5	H104	3055		2255	4255	2855	4855	3277	2452	2255ACAM	2255SCAM	
320/70-24	H100		TC-887DC									
320/75-24	H102		TC-887DC									

TRACTOR FIT CHART

Guide only, please check - Actual fit and clearance can vary.

*1 = CHECK LOADER / GRADER / FORESTRY
*2 = 2 LINK SPACING AVAILABLE

Tire Size	Round Twist Tractor *1 *2	Square Link *1 *2	HP H-Pattern	Tire Size	Round Twist Tractor *1 *2	Square Link *1 *2	HP H-Pattern	Tire Size	Round Twist Tractor *1 *2	Square Link *1 *2	HP H-Pattern
10-32			HP218	16.9-32	0877	0877S	HP266	365/70-18	0836	0836S	
10-38			HP232	16.9-34	0879	0879S	HP270	370/75-24	0859	0859S	HP240
10.5x80-18	0822	0822S	HP225	16.9-38	0880	0880S	HP272	380/70-20	0836	0836S	
10-16.5	0829	0829S		17.5-24	0874	0874S	HP263	380/70-24	0858	0858S	HP240
11.00-16	0822	0822S		* 17.5L-24	0874	0874S	HP263	380/85-30	0876	0876S	HP252
11.2-16			HP214	18.4-16.1	0881	0881S	HP264	380/85-34	0877	0877S	HP260
11.2-24	0836	0836S	HP226	18.4-24	0883	0883S	HP268	400/70-20	0858	0858S	
11.2-28	0838	0838S	HP226	18.4-26	0883	0883S	HP271	405/70-20	0858	0858S	HP260
11.2-32			HP218	18.4-28	0884	0884S	HP271	41x14.00-20	0858	0858S	HP240
11.2-34	0846	0846S		* 18.4-30	0885	0885S	HP271	420/70-24	0859	0859S	HP250
11.2-36	0846	0846S		* 18.4-34	0887	0887S	HP273	420/70-26			HP250
11.2-38	0862	0862S	HP232	18.4-38	0889	0889S	HP272	420/80-46	0894	0894S	HP272
11.2-44	0862	0862S	HP232	18.4-42	0894	0894S	HP277	420/85-28	0876	0876S	HP262
11.2-48			HP247	18.4-46			HP277	420/85-34			HP266
12.4-16	0836	0836S		* 19.5L-24	0883	0883S	HP268	420/90-30			HP266
12.4-24	0838	0838S	HP229	* 20.8-34	0890	0890S	HP272	425/85-24			HP262
12.4-28	0838	0838S	HP218	20.8-38	0892	0892S	HP276	43x16-20	0838		HP239
12.4-36	0862	0862S	HP232	21.5L-16.1			HP264	440/80-28	0884	0884S	HP271
12.4-38	0862	0862S	HP232	* 21L-24	0885	0885S	HP275	44X18-20	0858	0858S	
12.4-40			HP242	* 23.1-26	0891	0891S	HP273	460/85-34			HP272
12.4-42			HP242	23.1-30	0893	0893S	HP272	480/80-38	0889	0889S	HP273
12.5x80-18	0832	0832S	HP225	23.1-34	0895	0895S	HP282	480/80-42	0893	0893S	HP277
12-16.5	0822	0822S	HP225	230/95-32	0838	0838S	HP226	480/85-34	0887	0887S	HP273
13.5-16.1	0850	0850S	HP214	230/95-36	0856	0856S		520/85-38	0892	0892S	HP276
13.6-24	0858	0858S	HP240	230/95-44			HP270	540/65-30			HP271
13.6-26	8058	0858S	HP240	* 24.5-32			HP282	600/65-25	0887	0887S	HP273
13.6-28	0859	0859S	HP260	260/70-16	0829	0829S		600/65-28			HP271
13.6-36	0866	0866S	HP242	270/95-44			HP232	620/70-42			HP282
13.6-38	0866	0866S		* 28.1-34			HP282	620/75-32			HP282
13.9-36	0866	0866S	HP242	280/70-20	0822	0822S	HP225	8.3-16	3227	3227S	
14.5-20	0859	0859S	HP242	280/85-24			HP226	8.3-24	0822	0822S	
14.9-24	0859	0859S	HP240	300/70-20	0822	0822S	HP225	8.3-24	0822	0822S	
14.9-26	0869	0869S	HP250	315/75D15	0822	0822S	HP225	9.5-16	0829	0829S	
14.9-28	0869	0869S	HP252	320/70-24	0852	0852S	HP229	9.5-18	0822	0822S	
14.9-30	0876	0876S	HP252	320/85-24	0838	0838S	HP229	9.5-24	0832	0832S	HP214
14.9-38	0871	0871S	HP254	320/85-34			HP242	9.5-28	0836	0836S	HP214
14.9-46	0894	0894S		320/85-38	0874	0874S	HP260	9.5-32	0838	0838S	HP226
14-17.5	0850	0850S		320/90-46			HP254	9.5-36			HP218
15.5-38	0879	0879S	HP254	340/80-18	0836	0836S	HP229	9.5-38			HP218
* 15-19.5	0836	0836S	HP242	340/85-24			HP240	9.5-48			HP232
15-22.5	0852	0852S		340/85-28			HP260				
* 16.9-24	0874	0874S	HP260	340/85-38			HP260				
* 16.9-26	0876	0876S	HP262	355/80-20	0836	0836S	HP226				
* 16.9-28	0876	0876S	HP262	360/70-20	0836	0836S					
* 16.9-30	0885	0885S	HP271	360/70-28	0859	0859S					

LOADER / GRADER FIT CHART

Guide only, please check - Actual fit and clearance can vary.

*1 = CHECK LOADER / GRADER / FORESTRY
*2 = 2 LINK SPACING AVAILABLE

Tire Size	Round Twist Loader Grader *1 *2	Square Link	Square Link 2-Link Spacing	Square Link HP	Square Link Titan Diamond w/ wear bars
13.00-24	2612	2612S	2612S-2	7112HP	7112DLW
14.00-20	2612	2612S	2612S-2	7112HP	7112DLW
14.00-24	2615	2615S	2615S-2	7115HP	7115DLW
14.00-25	2615	2615S	2615S-2	7115HP	7115DLW
14.5-20	2612	2612S	2612S-2	7112HP	7112DLW
14.75/80-20	2612	2612S	2612S-2	7112HP	7112DLW
15.5-25	2612	2612S	2612S-2	7112HP	7112DLW
15-19.5	3265HD				
16.00-20	2624	2624S	2624S-2	7124HP	7124DLW
16.00-24	2627	2627S	2627S-2	7127HP	7127DLW
16.00-25	2627	2627S	2627S-2	7127HP	7127DLW
16.9-24	2615	2615S	2615S-2	7115HP	7115DLW
16.9-26	2615	2615S	2615S-2	7115HP	7115DLW
16.9-28				7115HP	7115DLW
17.5-25	2624	2624S	2624S-2	7124HP	7124DLW
17.5L-24	2615	2615S	2615S-2	7115HP	7115DLW
18.00-25	2636	2636S	2636S-2	7133HP	7133DLW
18.00-26	2636	2636S	2636S-2	7133HP	7133DLW
18.00-33	2642	2642S	2642S-2		
18.4-30				7133HP	7133DLW
18.4-34				7145HP	7145DLW
19.5L-24	2627	2627S	2627S-2	7127HP	7127DLW
20.5-25	2633	2633S	2633S-2	7133HP	7133DLW
20.8-34				7145HP	7145DLW
21.00-24	2648	2648S	2648S-2		
21.00-25	2648	2648S	2648S-2	7145HP	7145DLW
21.00-35	2654	2654S	2654S-2		
21L-24	2636	2636S	2636S-2	7133HP	7133DLW
23.1-26				7145HP	7145DLW
23.1-34				7145HP	7145DLW
23.5-25	2645	2645S	2645S-2	7145HP	7145DLW
24.00-25	2660	2660S	2660S-2	7157HP	7157DLW
24.00-35	2686	2686S	2686S-2		
24.5-32				7157HP	7157DLW
25.5-25	2645	2645S	2645S-2		
25/65-25				7145HP	7145DLW
25/65-33	2680	2680S	2680S-2		
26.5-25	2657	2657S	2657S-2	7157HP	7157DLW
26.5-29	2660	2660S	2660S-2	7157HP	7157DLW
29.5-25	2672	2672S	2672S-2	7172HP	7172DLW
29.5-29	2675	2675S	2675S-2	7175HP	7175DLW
29.5-35	2688	2688S	2688S-2		
30.5-32	2657	2657S	2657S-2	7172HP	7172DLW
33.5-33	2678	2678S	2678S-2		
37.5-33	2682	2682S	2682S-2		
385/95-24	2612	2612S	2612S-2		
39.5/85-20	2615	2615S	2615S-2		
400/70-20	2612	2612S	2612S-2	7112HP	7112DLW
44/18.00-20	2612	2612S	2612S-2		
445/65-19.5	2612	2612S	2612S-2		
495/55-22.5	2612	2612S	2612S-2		
550/65-25	2636	2636S	2636S-2		
555/70-25	2633	2612S	2612S-2		
600/65-25	2642	2642S	2642S-2		
625/70-20	2645	2645S	2645S-2		
650/65-25	2648	2648S	2648S-2		
705/70-25	2648	2648S	2648S-2		
750/65-25	2657	2657S	2657S-2		



2600 SERIES



HP SERIES



DLW SERIES

TRACTOR/LOADER/GRADER ADJUSTERS



CABLE CHAIN

- These chains are designed for use on autos having minimal clearance availability.
- These chains are designed for use with original equipment tires with high tread.
- SAE Class "S"



1000 Series

(Packed 1 Pair Per Bag)

Regular			
Stock No.	Wt./Pr.	Stock No.	Wt./Pr.
1014	4	1034	6
1018	5	1038	6
1022	5	1042	7
1026	5	1046	8
1030	5		

DIAGONAL CABLE CHAIN

- Longer life alloy rollers
- Smooth ride
- Easy installation
- Includes tighteners
- SAE Class "S"



300DC Series

(Packed 1 Pair Per Bag)

Stock No.	Wt./Pr.	Cross Chain No.	Rubber Tightener
TC-315DC	9	1334DC	TC-1172
TC-319DC	9	1336DC	TC-1172
TC-323DC	9	1338DC	TC-1172
TC-327DC	9	1338DC	TC-1172
TC-329DC	10	1338DC	TC-1172
TC-331DC	10	1340DC	TC-1172
TC-335DC	10	1342DC	TC-1172
TC-339DC	11	1342DC	TC-1174
TC-343DC	11	1344DC	TC-1174

TIRE SOCK - ALTERNATIVE TRACTION DEVICE (ATD)

- 100% Polyester
- Ideal for low clearance vehicle
- Smooth, quiet ride
- Compact, lightweight, machine washable
- Easy installation
- Less than Class "S"



(Packed 1 Pair Per Pair)

Stock No.	Wt./Pr.
H54	1
H58	2
H62	2
H66	2
H70	2
H72	2
H74	2



H Series

PASSENGER TIRE CHAIN - SEE FIT CHART FOR FITMENTS: PGS 4-13

“PL” 1100 SERIES LINK CHAIN

- These chains are designed for use on autos having minimal clearance availability.
- These chains are designated for use with original equipment size tires with highway tread.
- DO NOT USE TYPE “PL” CHAINS ON SNOW TIRES.
- SAE Class “S”



(Packed 1 Pair Per Box, 4 Pair Per Master Carton)

Stock No.	Wt./Pr.	Cross Chain No.
1110	8	5414
1114	8	5414
1118	10	5414
1122	10	5414
1126	10	5419
1130	11	5419
1134	11	5420
1138	12	5420
1142	13	5422
1146	15	5422



1100 All Link

CAR CHAIN

WARNING: Check owner’s manual to determine if SAE CLASS “S” chains are required. 1979 or newer automobiles may have limited clearances.

- SAE Class “U”



Regular (Type PL)

V-Bar (Type RP)

(Packed 1 Pair Per Box, 4 Pair Per Master Carton)

Regular Highway Service (Type PL)

Regular		
Stock No.	Wt./Pr.	Cross Chain No.
1230	15	5220
1240	17	5220
1250	19	5222
1254	17	5222

V-Bar Reinforced (Type RP)

Regular		
Stock No.	Wt./Pr.	Cross Chain No.
1830	17	5820
1840	18	5820
1850	21	5822
1854	19	5822

TITAN DIAMOND ALLOY SQUARE LINK

- The TITAN DIAMOND is designed for excellent traction and a smooth ride.
- SAE Class “S”
- Can be installed without moving vehicle, no adjuster needed.

For repair parts see page 46

(Packed 1 Pair Per Bag, 4 Pair per Master Carton)

Stock No.	Wt./Pr.	Cross Chain No.
1505	8 lbs.	505XC
1510	8 lbs.	510XC
1515	8 lbs.	515XC
1520	9 lbs.	520XC
1525	9 lbs.	525XC
1530	9 lbs.	530XC
1535	10 lbs	535XC
1540	10 lbs	540XC
1545	11 lbs.	545XC
1547	12 lbs.	547XC
1550	12 lbs.	550XC
1553	12 lbs.	553XC
1555	12 lbs.	555XC



Rear Connector



1500 Series

CABLE CHAIN

- SAE Class "S"
- For Light Truck on highway use only.

(Packed 1 Pair Per Bag)

Stock No.	Wt./Pr.	Cross Chain No.	Cross Chain Length
2014	13	8821	13
2016	12	8821	13
2019	11	8821	13
2021	12	8821	13
2028	13	8825	15
2029	12	8825	15
3010	13	8825	15
3027	12	8853	15.6
3029	14	8859	18
3031	15	8859	18
3035	16	8859	18



2000 Series



DIAGONAL CABLE CHAIN

- Longer life alloy rollers
- Smooth ride
- Easy installation
- Includes tighteners
- SAE Class "S"

(Packed 1 Pair Per Bag)

Stock No.	Wt./Pr.	Cross Chain	Rubber Tightener
729DC	14	1742DC	1174
735DC	14	1742DC	1176
741DC	14	1744DC	1176
747DC	15	1746DC	1176
751DC	15	1746DC	1176



Rear Connector



700 Series

TIRE SOCK - ALTERNATIVE TRACTION DEVICE (ATD)

- 100% Polyester
- Ideal for low clearance vehicle
- Smooth, quiet ride
- Compact, lightweight, machine washable
- Easy installation
- Less than Class "S"

(Packed 1 Pair Per Bag)

Stock No.	Wt./Pr.
H72	2
H74	2
H78	5
H88	6
H90	6



H72, H74



H78, H88, H90



H Series



LIGHTWEIGHT TITAN DIAMOND ALLOY SQUARE LINK CHAIN

For repair parts see page 46

- The TITAN DIAMOND "LT" is designed for excellent traction and smooth ride.
- Can install without moving vehicle, no adjuster needed.
- Pull chain tightening system for quick and easy installation.
- SAE Class "S"
- Not designed for snow plows or tow trucks.

(Packed 1 Pair Per Bag)

Stock No.	Wt./Pr.	Cross Chain
1545	11	545XC
1550	12	550XC
1553	12	553XC
1555	12	555XC
2317	14	317XC
2318	14	318XC
2319	14	319XC
2321	14	321XC
2323	15	323XC
2324	14	324XC
2326	16	326XC
2327	16	327XC
2335	16	335XC
2337	17	337XC



Rear connector



**PULL
CHAIN
TYPE**

1500 + 2300 Series

HEAVY DUTY TITAN DIAMOND ALLOY SQUARE LINK CHAIN

For repair parts see page 46

- The TITAN DIAMOND "HD" is designed for excellent traction and smooth ride.
- Can install without moving vehicle, no adjuster needed.
- Pull Chain tightening system for quick and easy installation.
- SAE Class "U"
- Not designed for snow plows or tow trucks.

(Packed 1 Pair Per Bag)

Stock No.	Wt./Pr.	Cross Chain
2517	21	517XC
2518	21	518XC
2519	21	519XC
2521	21	521XC
2524	22	524XC
2526	24	526XC
2533	23	533XC
2536	24	536XC
2537	25	537XC
2539	27	539XC



Rear connector



**PULL
CHAIN
TYPE**

2500 Series

LIGHT TRUCK CHAIN

- Round Twist Carbon
- For highway use only
- Single/Dual Mounts available
- Available in Regular and CAM style



Multi-Arm Adjuster sold separately



Highway use (not for plows, forklifts or tow trucks)

(Packed 1 Pair Per Bag)

(Packed 1/2 Pair Per Bag)

Single Mount

Single Mount				Dual Mount				Cross Chain No.	Wire Size
Regular		CAM-Style		Regular		CAM-Style			
Stock No.	Wt./Pr.	Stock No.	Wt./Pr.	Stock No.	Wt./Pr.	Stock No.	Wt./Pr.		
2209	20	2209CAM	22	4209	43	4209CAM	46	6219	5.5MM
2211	23	2211CAM	25	4211	47	4211CAM	52	6219	5.5MM
2214	27	2214CAM	29	4214	50	4214CAM	52	6221	5.5MM
2216	22	2216CAM	23	4217	40	4217CAM	45	6221	5.5MM
2219	24	2219CAM	25	4219	44	4219CAM	46	6221	5.5MM
2221	26	2221CAM	27	4221	46	4221CAM	48	6221	5.5MM
2228	28	2228CAM	29	4231	52	4231CAM	54	6225	5.5MM
2229	24	2229CAM	25		116				5.5MM
2233	27	2233CAM	38	4233	72	4233CAM	79	6251	7MM
2237	40	2237CAM	42	4222	89	4222CAM	93	6251	7MM

WIDE BASE CHAIN

- Designed for wide base tires
- Reinforced to add traction for icy/off-road conditions
- Available in Regular and CAM style



MA2

Single Mount



Highway use (not for plows, forklifts or tow trucks)

(Packed 1 Pair Per Bag)

Regular		CAM-Style		Cross Chain No.	Wire Size
Stock No.	Wt./Pr.	Stock No.	Wt./Pr.		
3210	25	3210CAM	27	6225	5.5mm
3227	34	3227CAM	36	6253	7mm
3229	37	3229CAM	39	6259	7mm
3231	40	3231CAM	43	6259	7mm
3235	43	3235CAM	46	6259	7mm
3237	38	3237CAM	40	6265	7mm
3249	48	3249CAM	49	6267	7mm
3251	43	3251CAM	45	6267	7mm
3255	68	3255CAM	70	7213	8mm
3257	72	3257CAM	82	7213	8mm
3259	63	3259CAM	64	7214	8mm

Multi-Arm Adjuster sold separately

LIGHT TRUCK CHAIN: V-BAR

- Reinforced to add traction for icy road conditions
- Single/Dual Mounts available
- Available in Regular and CAM style



Single Mount

Multi-Arm Adjuster sold separately



Dual Mount

Highway use: (not for plows, forklifts or tow trucks)

(Packed 1 Pair Per Bag)

(Packed 1/2 Pair Per Bag)

Single Mount				Dual Mount				Cross Chain No.	Wire Size
Regular		CAM-Style		Regular		CAM-Style			
Stock No.	Wt./Pr.	Stock No.	Wt./Pr.	Stock No.	Wt./Pr.	Stock No.	Wt./Pr.		
2809	22	2809CAM	26	4809	44	4809CAM	48	6819	5.5MM
2811	25	2811CAM	27	4811	47	4811CAM	52	6819	5.5MM
2814	30	2814CAM	31	4814	54	4814CAM	58	6821	5.5MM
2816	23	2816CAM	25	4817	44	4817CAM	49	6821	5.5MM
2819	26	2819CAM	27	4819	49	4819CAM	53	6821	5.5MM
2821	28	2821CAM	29	4821	52	4821CAM	57	6821	5.5MM
2828	31	2828CAM	32	4831	58	4831CAM	60	6825	5.5MM
2829	27	2829CAM	28					6825	5.5MM
2833	41	2833CAM	42	4833	79	4833CAM	84	6822	7MM
2837	45	2837CAM	46	4822	96	4822CAM	101	6822	7MM

WIDE BASE: V-BAR

- Reinforced to add traction for icy road conditions
- Available in Regular and CAM style

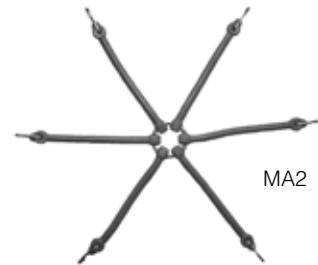

MA2

Single Mount



Highway use: (not for plows, forklifts or tow trucks)

(Packed 1 Pair Per Bag)

Regular		CAM-Style		Cross Chain No.	Wire Size
Stock No.	Wt./Pr.	Stock No.	Wt./Pr.		
3810	28	3810CAM	30	6825	5.5mm
3827	38	3827CAM	40	6853	7mm
3829	41	3829CAM	43	6859	7mm
3831	45	3831CAM	47	6859	7mm
3835	49	3835CAM	51	6859	7mm

Multi-Arm Adjuster sold separately

LIGHT TRUCK CHAIN: ALLOY SQUARE LINK

- Designed for Durability and Traction
- Off-Road Heavy Duty use: (for plows, forklift or tow truck)
- Made of Alloy for Longer Life
- Available in Regular and CAM style
- Single/Dual Mounts available



Single Mount



5.5mm CAM Type

(Packed 1 Pair Per Bag)

(Packed 1/2 Pair Per Bag)

Single Mount		Dual Mount	
Stock No.	Wt./Pr.	Stock No.	Cross Chain No.
2214SCAM	31	4214SCAM	6221S
2216SCAM	25	4217SCAM	6221S
2219SCAM	27	4219SCAM	6221S
2221SCAM	29	4221SCAM	6221S
2228SCAM	31	4231SCAM	6225S
2229SCAM	26		6225S

7mm NON-CAM HD

(Packed 1 Pair Per Bag)

(Packed 1/2 Pair Per Bag)

Single Mount		Dual Mount	
Stock No.	Wt./Pr.	Stock No.	Cross Chain No.
2214SHD	39	4214SHD	6221SHD
2216SHD	31	4217SHD	6221SHD
2219SHD	35	4219SHD	6221SHD
2221SHD	35	4221SHD	6221SHD
2228SHD	42	4231SHD	6225SHD
2229SHD	39		6225SHD

WIDE BASE: ALLOY SQUARE LINK

- Designed for Durability and Traction
- Off-Road Heavy Duty use: (for plows, forklift or tow truck)
- Made of Alloy for Longer Life
- Available in Regular and CAM style



Single Mount



MA2

Multi-Arm Adjuster sold separately

5.5mm CAM Type

(Packed 1 Pair Per Bag)

Stock No.	Wt./Pr.	Cross Chain No.
3210SCAM	30	6225S

7mm CAM Type

(Packed 1 Pair Per Bag)

Stock No.	Wt./Pr.	Cross Chain No.
3227SCAM	44	6253S
3229SCAM	47	6259S
3231SCAM	51	6259S
3235SCAM	56	6259S

8mm CAM Type

(Packed 1 Pair Per Bag)

Stock No.	Wt./Pr.	Cross Chain No.
3227SHDCAM	48	6260S
3229SHDCAM	52	6263S
3231SHDCAM	58	6263S
3235SHDCAM	62	6263S

LIGHT TRUCK CHAIN: MUD SERVICE

- Heavy Duty Mud and Off-Road
- Single/Dual Mounts available
- CAMs not recommended



Single Mount
(Packed 1 Pair Per Bag)



Dual Mount
(Packed 1/2 Pair Per Bag)

Multi-Arm Adjuster sold separately

Wire Size	Single Mount			Dual Mount		
	Stock No.	Wt./Pr.	Cross Chain No.	Stock No.	Wt./Pr.	Cross Chain No.
8mm	2433	33	6256			
8mm	2435	36	6256			
8mm	2437	39	6256	4419	80	6256
8mm	2437	39	6256	4412	72	6256
8mm	2439	41	6260	4425	75	6260
8mm	2440	46	6260	4432	84	6260
10mm	2441	72	6434	4435	132	6434

WIDE BASE MUD SERVICE

- Heavy Duty Mud and Off-Road
- Single/Dual Mounts available
- CAMs not recommended

(Packed 1 Pair Per Bag)

Regular		Cross Chain No.	Wire Size
Stock No.	Wt./Pr.		
3410	41	6260	8mm
3427	62	6434	10mm
3429	67	6434	10mm
3431	72	6434	10mm
3435	76	6434	10mm



MA2

Multi-Arm Adjuster sold separately



Single Mount

TRUCK CABLE CHAINS

- Lightweight
- Easy install
- Single/Dual Mounts available

(Packed 1 Pair Per Bag)

(Packed 1/2 Pair Per Bag)

Single Mount			Dual Mount		
Stock No.	Wt./Pr.	Cross Chain No.	Stock No.	Wt./Pr.	Cross Chain No.
2039	15	8851	4039	30	8851
2041	16	8851	4041	30	8851
2045	17	8851	4045	32	8851
2047	17	8853	4047	33	8853
2049	18	8853	4049	35	8853



Single Mount

Dual Mount

WIDE BASE

(Packed 1 Pair Per Bag)

Single		
Stock No.	Wt./Pr.	Cross Chain No.
3055	23	8813
3057	25	8813
3061	25	8814
3065	20	8815
3069	23	8815
3071	24	8815



TITAN DIAGONAL CABLE CHAINS

- Long Life Alloy Rollers
- Smooth Ride
- Easy Install
- Tighteners included

Single		
Stock No.	Wt./Pr.	Cross Chain No.
877DC	40	8265
881DC	43	8263
887DC	41	8265
891DC	49	8267
897DC	44	8277



TIRE SOCK - ALTERNATIVE TRACTION DEVICE (ATD)

- Approved alternative to cable and tire chain
- 100% Polyester
- Ideal for low clearance vehicle
- Smooth, quiet ride
- Compact, lightweight, machine washable
- Easy installation



(Packed 1 Pair Per Bag)

Stock No.	Wt./Pr.
H94	6
H96	8
H98	9
H100	9
H102	9
H104	9
H106	9
H108	9



TRUCK CHAIN

- Designed for Highway Use
- Single/Dual Mounts Available
- Available in Regular and CAM style



Single Mount



Dual Mount

Not recommended for Off-Road
(Packed 1 Pair Per Bag)

(Packed 1/2 Pair Per Bag)

Single Mount				Dual Mount				Cross Chain No.	Wire Size
Regular		CAM-Style		Regular		CAM-Style			
Stock No.	Wt./Pr.	Stock No.	Wt./Pr.	Stock No.	Wt./Pr.	Stock No.	Wt./Pr.		
2233	27	2233CAM	38	4233	72	4233CAM	79	6251	7MM
2237	40	2237CAM	42	4222	89	4222CAM	93	6251	7MM
2239	42	2239CAM	45	4239	78	4239CAM	79	6251	7MM
2241	45	2241CAM	48	4241	82	4241CAM	86	6251	7MM
2245	48	2245CAM	51	4245	87	4245CAM	92	6251	7MM
2247	47	2247CAM	50	4247	87	4247CAM	89	6253	7MM
2249	50	2249CAM	53	4249	91	4249CAM	94	6253	7MM
2251	64	2251CAM	66	4251	116	4251CAM	119	6260	8MM
2253	73	2253CAM	74	4253	131	4253CAM	141	6260	8MM
2255	66	2255CAM	68	4255	118	4255CAM	124	6263	8MM
2257	75	2257CAM	77	4257	145	4257CAM	150	6263	8MM
2271	83	2271CAM	86	4271	154	4271CAM	162	6266	8MM
2273	105	2273CAM	109	4273	171	4273CAM	183	6266	8MM

TRUCK CHAIN: V-BAR

- Reinforced to add traction for Ice and Off-Road
- Single/Dual Mounts Available
- Available in Regular and CAM style



Single Mount



Dual Mount

(Packed 1 Pair Per Bag)

(Packed 1/2 Pair Per Bag)

Single Mount				Dual Mount				Cross Chain No.	Wire Size
Regular		CAM-Style		Regular		CAM-Style			
Stock No.	Wt./Pr.	Stock No.	Wt./Pr.	Stock No.	Wt./Pr.	Stock No.	Wt./Pr.		
2833	27	2833CAM	38	4833	72	4833CAM	84	6822	7MM
2837	40	2837CAM	42	4822	89	4822CAM	101	6822	7MM
2839	42	2839CAM	45	4839	78	4839CAM	94	6822	7MM
2841	45	2841CAM	48	4841	82	4841CAM	96	6822	7MM
2845	48	2845CAM	51	4845	87	4845CAM	104	6822	7MM
2847	47	2847CAM	50	4847	87	4847CAM	103	6853	7MM
2849	50	2849CAM	53	4849	91	4849CAM	106	6853	7MM
2851	64	2851CAM	66	4851	116	4851CAM	133	6860	8MM
2853	73	2853CAM	74	4853	131	4853CAM	152	6860	8MM
2855	66	2855CAM	68	4855	118	4855CAM	140	6863	8MM
2857	75	2857CAM	77	4857	145	4857CAM	150	6863	8MM
2871	83	2871CAM	86	4871	154	4871CAM	170	6866	8MM
2873	105	2873CAM	109	4873	171	4873CAM	183	6866	8MM

LONG LIFE ROUND TWIST ALLOY TRUCK CHAIN

- Long Mileage
- Heavy Truck / Bus
- Single/Dual Mounts Available
- Available in Regular and CAM style



Single Mount



Dual Mount

7mm - 9/32

(Packed 1 Pair Per Bag)

(Packed 1/2 Pair Per Bag)

Single Mount			Dual Mount		
Stock No.	Wt./Pr.	Cross Chain No.	Stock No.	Wt./Pr.	Cross Chain No.
2239ACAM	43	6251A	4239ACAM	79	6251A
2241ACAM	47	6251A	4241ACAM	86	6251A
2245ACAM	51	6251A	4245ACAM	91	6251A
2247ACAM	50	6253A	4247ACAM	90	6253A
2249ACAM	53	6253A	4249ACAM	96	6253A

8mm - 5/16

(Packed 1 Pair Per Bag)

(Packed 1/2 Pair Per Bag)

Single Mount			Dual Mount		
Stock No.	Wt./Pr.	Cross Chain No.	Stock No.	Wt./Pr.	Cross Chain No.
2251ACAM	66	6260A	4251ACAM	123	6260A
2255ACAM	73	6263A	4255ACAM	128	6263A
2257ACAM	76	6263A	4257ACAM	152	6263A

EXTRA LONG LIFE TRUCK CHAIN

- Extra Durable, HD Heavy Truck / Bus CAM Type
- H.D. Alloy Round Twist Link

8mm - 5/16

(Packed 1 Pair Per Bag)

(Packed 1/2 Pair Per Bag)

Single Mount			Dual Mount		
Stock No.	Wt./Pr.	Cross Chain No.	Stock No.	Wt./Pr.	Cross Chain No.
2245AHDCAM	69	6260A	4245AHDCAM	118	6260A
2247AHDCAM	62	6263A	4247AHDCAM	102	6263A
2249AHDCAM	71	6263A	4249AHDCAM	127	6263A

ALLOY SQUARE LINK TRUCK CHAIN

- Designed for Durability and Traction, On and Off-Road
- Made from Alloy for longer life
- Available in Regular and CAM style



7mm - 9/32

CAM				Cross Chain No.
Single Mount		Dual Mount		
Stock No.	Wt./Pr.	Stock No.	Wt./Pr.	
2237SCAM	45	4222SCAM	78	6251S
2239SCAM	48	4239SCAM	86	6251S
2241SCAM	52	4241SCAM	92	6251S
2245SCAM	60	4245SCAM	106	6251S
2247SCAM	56	4247SCAM	110	6253S
2249SCAM	64	4249SCAM	114	6253S

8mm - 5/16

2251SCAM	72	4251SCAM	126	6260S
2255SCAM	74	4255SCAM	132	6263S

(Singles Packed 1 Pair Per Bag - Duals Packed 1/2 Pair Per Bag)

Multi-Arm Adjuster sold separately



Single Mount



Dual Mount

- Designed for Off-Road Extreme Applications (Dump Truck, Plowing, Emergency Vehicles)

8mm - 5/16

CAM				Cross Chain No.
Single Mount		Dual Mount		
Stock No.	Wt./Pr.	Stock No.	Wt./Pr.	
2237SHDCAM	53	4222SHDCAM	95	6260S
2239SHDCAM	56	4239SHDCAM	100	6260S
2241SHDCAM	62	4241SHDCAM	110	6260S
2245SHDCAM	70	4245SHDCAM	125	6260S
2247SHDCAM	71	4247SHDCAM	126	6263S
2249SHDCAM	74	4249SHDCAM	132	6263S

TWISTED SQUARE LINK ALLOY TRUCK CHAIN

- Designed for Durability and Traction
- Off-Road, Heavy Duty use: (for plows, forklift or tow truck)
- Made of Alloy for Longer Life
- Available in Regular and CAM style



Single Mount

7mm - 9/32 (Singles Packed 1 Pair Per Bag - Duals Packed 1/2 Pair Per Bag)

CAM				Cross Chain No.
Single Mount		Dual Mount		
Stock No.	Wt./Pr.	Stock No.	Wt./Pr.	
2237STCAM	45	4222STCAM	78	6251ST
2239STCAM	48	4239STCAM	86	6251ST
2241STCAM	52	4241STCAM	92	6251ST
2245STCAM	60	4245STCAM	106	6251ST
2247STCAM	56	4247STCAM	110	6253ST
2249STCAM	64	4249STCAM	114	6253ST

8mm - 5/16

2251STCAM	59	4251STCAM	111	6260ST
2255STCAM	74	4255STCAM	132	6263ST

STUDDED TRUCK CHAIN

- Recommended for Off-Road Use Only
- Single/Dual Mounts Available
- Available in Regular and CAM style
- Available in Heavy Duty



Single Mount

(Packed 1 Pair Per Bag)

(Packed 1/2 Pair Per Bag)

Single Mount				Dual Mount				Cross Chain No.	Wire Size
Regular		CAM Style		Regular		CAM Style			
Stock No.	Wt./Pr.	Stock No.	Wt./Pr.	Stock No.	Wt./Pr.	Stock No.	Wt./Pr.		
2239STUD	41	2239STUDCAM	43	4239STUD	102	4239STUDCAM	104	6251STD	8MM
2241STUD	52	2241STUDCAM	54	4241STUD	105	4241STUDCAM	107	6251STD	8MM
2245STUD	66	2245STUDCAM	68	4245STUD	118	4245STUDCAM	120	6251STD	8MM
2247STUD	65	2247STUDCAM	67	4247STUD	117	4247STUDCAM	119	6253STD	8MM
2249STUD	68	2249STUDCAM	70	4249STUD	125	4249STUDCAM	127	6253STD	8MM
2255STUD	80	2255STUDCAM	82	4255STUD	158	4255STUDCAM	160	6263STD	8MM

MUD SERVICE TRUCK CHAIN

- Heavy Duty Mud and Off-Road
- Single/Dual Mounts Available
- CAMS not recommended

10mm - 3/8

(Packed 1 Pair Per Bag)

(Packed 1/2 Pair Per Bag)



Single Mount			Dual Mount		
Stock No.	Wt./Pr.	Cross Chain No.	Stock No.	Wt./Pr.	Cross Chain No.
2441	70	6434	4435	129	6434
2445	76	6434	4437	140	6434
2448	82	6434	4448	150	6434
2452	88	6434	4461	164	6434
2470	102	6438	4470	191	6438
2486	103	6438	4486	179	6438



Single Mount

WIDE BASE TRUCK CHAIN

- Designed for Wide Base Tires
- On and Off-Road
- Available in Regular and CAM style

8mm - 5/16

(Packed 1 Pair Per Bag)

Regular			CAM-Style		
Stock No.	Wt./Pr.	Cross Chain No.	Stock No.	Wt./Pr.	Cross Chain No.
3255	68	7213	3255CAM	70	7213
3257	72	7213	3257CAM	74	7213
3259	60	7214	3259CAM	61	7214
3261	79	7214	3261CAM	82	7214
3265	63	7215	3265CAM	64	7215
3267	67	7215	3267CAM	69	7215
3269	67	7215	3269CAM	70	7215
		ALLOY	3269ACAM	71	7215A
3271	74	7215	3271CAM	76	7215
3273	79	7216	3273CAM	81	7216
3275	83	7216	3275CAM	85	7216
3277	86	7216	3277CAM	88	7216

Multi-Arm Adjuster sold separately



Single Mount

SQUARE LINK TRUCK CHAIN WIDE BASE

- Square Link Alloy for added Traction and longer life
- On and Off-Road
- Other sizes available. Please call for fitment
- Available in Regular and CAM style

8mm - 5/16

(Packed 1 Pair Per Bag)

Stock No.	Wt./Pr.	Cross Chain No.
3255SCAM	78	7213S
3269SCAM	78	7215S
3271SCAM	84	7215S



Single Mount

TITAN DIAMOND PATTERN ALLOY SQUARE LINK CHAIN

- Alloy Diamond Pattern
- Reversible
- Pull Chain Tightening System

7mm - 9/32

(Packed 1 Pair Per Bag)

Tire Size	Single		
	Stock No.	Wt./Pr.	Cross Chain No.
245/70-19.5 265/70-19.5	275	45	275XC
10.00-20 11-22.5 315/70-22.5 275/80-22.5	310	72	310XC
11-24.5 10.00-22 315/80-22.5 12R-22.5 12.00-20	315	73	315XC
445/50-22.5 385/65-22.5	445	72	445XC



TITAN TRACTOR CHAIN

- Ladder Style Chain
- On or Off-Road
- 2 & 4 link spacing available



Round Twist Carbon



Square Link Alloy

(Packed 1/2 Pair Per Bag)

Tire Size	Round Twist Carbon			Square Link Alloy			Wire Size
	Stock No.	Wt./Pr.	Cross Chain No.	Stock No.	Wt./Pr.	Cross Chain No.	
8.3-16	3227	35	6253	3227S	38	6253S	7mm
8.3-24 9.5-18 11.00-16 12-16.5 10.5x80-18	0822	75	6434	0822S	82	6434S	10mm
9.5-16 10-16.5	0829	59	6434	0829S	79	6434S	10mm
9.5-24 300/70-20 12.5/80-18 320/80-18	0832	76	6434	0832S	83	6434S	10mm
9.5-28 340/80-18 13.5-16 13.6-16 365/70-18 11.2x24 15x19.5	0836	83	6445	0836S	91	6445S	10mm
11.2-28 9.5-32 11.2-24 43x16x20	0838	103	6445	0838S	113	6445S	10mm
11.2-34 11.2-36	0846	121	6445	0846S	132	6445S	10mm
14-17.5 13.6-16 13.5-16.1	0850	84	7420	0850S	92	7420S	10mm
12.4-24 15-22.5	0852	101	6445	0852S	111	6445S	10mm
12.4-28	0856	106	6445	0856S	117	6445S	10mm
13.6-24 13.6-26 41 x 14-20 400/70-20 405/70-20 44 x 18-20 380/70-19.5	0858	115	7420	0858S	124	7420S	10mm
13.6-28 14.9-24 420/70-24 370/75-24	0859	117	7420	0859S	128	7420S	10mm
11.2-38 12.4-36 12.4-38 11.2-44	0862	137	6445	0862S	150	6445S	10mm
13.6-38 13.6-36 13.9-36	0866	144	7420	0866S	154	7420S	10mm
14.9-26 14.9-28 370/75-28	0869	132	7420	0869S	148	7420S	10mm
14.9-38	0871	154	7420	0871S	169	7420S	10mm
16.9-24 17.5L-24	0874	129	7426	0874S	141	7426S	10mm
16.9-26 16.9-28 14.9-30 380/85-30 400/75-28	0876	150	7426	0876S	145	7426S	10mm
16.9-30 16.9-32	0877	155	7426	0877S	170	7426S	10mm
16.9-34 15.5-38	0879	164	7426	0879S	181	7426S	10mm
16.9-38	0880	181	7426	0880S	199	7426S	10mm
18.4-16.1	0881	134	9562	0881S	149	9562S	11mm
18.4-24 19.5L-24 18.4-26	0883	177	9562	0883S	182	9562S	11mm
18.4-28 440/80-28	0884	187	9562	0884S	199	9562S	11mm
18.4-30 21L-24	0885	211	9562	0885S	231	9562S	11mm
18.4-34 480/85-34	0887	213	9562	0887S	233	9562S	11mm
18.4-38 480/85-38	0889	217	9562	0889S	264	9562S	11mm
20.8-34	0890	289	6650	0890S	317	6650S	11mm
23.1-26	0891	223	9567	0891S	243	9567S	11mm
20.8-38 520/85-38	0892	245	6650	0892S	281	6650S	11mm
23.1-30 480/80-42	0893	253	9567	0893S	278	9567S	11mm
18.4-42 14.9-46 420/80-46	0894	245	9562	0894S	269	9562S	11mm
23.1-34	0895	345	9567	0895S	380	9567S	11mm

TITAN HP TRACTOR CHAIN

- H-Pattern keeps chain on top of lugs to provide more traction on side hills, as well as forward and backward motion.



10mm - 3/8 (Packed 1/2 Pair Per Bag)

Tire Size	Stock No.	Weight Per Pair	Replacement Cross Chain
9.5-24 9.5-28 11.2-16	HP214	95	HP292
9.5-32 11.2-28 230/95-32 355/80-20 11.2-24 280/85-24	HP226	124	HP292
10.5 x 80-18 12-16.5 280/70-20 315/75-15 12.5 x 80-18 300/70-20	HP225	89	HP293
12.4-24 12.4-16 320/70-24 320/85-24 340/80-18 355/55-625	HP229	118	HP293
9.5-36 9.5-38 11.2-32 12.4-28	HP218	128	HP293
11.2-38 11.2-44 12.4-36 12.4-38 270/90-44 9.5-48	HP232	158	HP293
43x16-20	HP239	143	HP295
13.9-36 320/85-34 12.4-40 12.4-42 13.6-36 15-19.5 13.6-38 15-625	HP242	152	HP294
13.6-24 13.6-26 14.9-24 380/70-24 385/85-24 340/85-24 370/75-24 420/70-24	HP240	143	HP295
14.9-26 420/70-26 420/70-24	HP250	158	HP295
14.9-28 14.9-30 380/85-30	HP252	156	HP295
13.6-28 16.9-24 320/85-38 340/85-28 380/85-34 405/70-20	HP260	164	HP296
14.9-38 15.5-38 320/90-46	HP254	178	HP296
17.5-24 15.5-25	HP263	143	HP297
16.9-26 16.9-28 420/85-28 425/85-24 480/70-24	HP262	151	HP297
16.9-32 420/90-30 420/85-34	HP266	186	HP297
16.9-34 230/90-44	HP270	184	HP297
18.4-16 21.5L-16.1	HP264	130	HP298
18.4-24 19.5L-24 17.5-25	HP268	150	HP298
16.9-30 18.4-26 18.4-28 18.4-30 540/65-30 550/65-25 600/65-28 440/80-28 480/70-30	HP271	190	HP298
18.4-34 480/85-34 600/65-25 23.1-26	HP273	209	HP298
16.9-38 18.4-38 20.8-34 380/90-50 420/80-46 460/85-34 480/80-38 23.1-30	HP272	225	HP298
18.4-42 18.4-46 380/90-54 480/80-46 480/80-42	HP277	244	HP298
21L-24	HP275	163	HP299
20.8-38 520/85-38 650/65-38	HP276	242	HP299
24.5-32 23.1-34 28.1-34 620/70-42 650/75-32	HP282	236	HP302

TITAN LOADER/GRADER CHAIN



Round Twist Carbon

- Designed for Off-Road, Wheel Loaders, Plows, etc.
- 2 & 4 link spacing available
- Ladder Style Chain

(Packed 1/2 Pair Per Package)

Tire Size	Round Twist Carbon			Wire Size
	Stock No.	Wt./Pr.	Cross Chain No.	
13.00-24 14.00-20 15.5-25 14.75 x 80-20 14.5-20 14.00-20 44 x 18.00-20 445/65-19.5 495/55-22.5 400/70-20	2612	112	6630	10mm
14.00-24 14.00-25 395/85-20 385/95-24 17.5L-24 385/95-25 370/75-28	2615	127	6630	10mm
16.00-20 17.5-25 420/70-24	2624	157	6640	11mm
16.00-24 16.00-25 19.5L-24 445/95-25	2627	176	6640	11mm
20.5-25 525/80-25	2633	190	6650	11mm
18.00-25 18.00-26 21L-24 555/70-25 550/65-25 505/95-25	2636	208	6650	11mm
18.00-33 600/65-25	2642	246	6650	11mm
23.5-25 25.5-25 625/70-20	2645	344	6660	13mm
21.00-24 21.00-25 705/70-25 650/65-25	2648	368	6660	13mm
21.00-35	2654	438	6660	13mm
26.5-25 750/65-25	2657	430	6670	13mm
24.00-25 26.5-29	2660	472	6670	13mm
29.5-25 30 x 65-29 755/65-29	2672	482	6680	13mm
29.5-29 710/70-38 800/65-29	2675	531	6680	13mm
33.5-33	2678	589	6690	13mm

*V-Bar also available

SQUARE LINK ALLOY

- Designed for Off-Road, Wheel Loaders, Plows, etc.
- 2 & 4 link spacing available
- Made from Alloy for Extra Long Life



4 Link Spacing



2 Link Spacing

Tire Size	4 Link Spacing		2 Link Spacing		Cross Chain No.	Wire Size
	Stock No.	Wt./Pr.	Stock No.	Wt./Pr.		
13.00-24 15.5-25 445/45-18 495/55-22.5 400/70-20	2612S	122	2612S-2	204	6630S	10mm
14.00-24 14.00-25 395/85-20 370/75-28	2615S	140	2615S-2	236	6630S	10mm
17.5-25 16.00-20 420/70-24	2624S	204	2624S-2	322	6640S	11.1mm
16.00-24 16.00-25 445/95-25	2627S	230	2627S-2	378	6640S	11.1mm
20.5-25 525/85-25	2633S	226	2633S-2	362	6650S	11.1mm
18.00-25 18.00-26 21L-24 555/70-25 550/65-25	2636S	253	2636S-2	398	6650S	11.1mm
18.00-33 600/65-25	2642S	300	2642S-2	490	6650S	11.1mm
23.5-25 25 x 65-25	2645S	380	2645S-2	521	6660S	13mm
21.00-35	2654S	406	2654S-2	653	6660S	13mm
26.5-25 750/65-25	2657S	406	2657S-2	630	6670S	13mm
29.5-25 30 x 65-29	2672S	418	2672S-2	1175	6680S	13mm
29.5-29 710/70-38 800/65-29	2675S	450	2675S-2	763	6680S	13mm

TITAN HP

- Alloy Square Link Chains
- For Plows, Graders, Loaders, etc.
- H-Pattern for better traction and smoother ride



Tire Size		10mm			11.1mm			13mm		
		Regular			Regular			Regular		
Loader Grader	Back Hoe Tractor	Stock No.	Wt./ Pr.	Cross Chain No.	Stock No.	Wt./ Pr.	Cross Chain No.	Stock No.	Wt./ Pr.	Cross Chain No.
13.00-24 14.5-20 14.00-20 15.5-25	13.6-28 420/70-24 385/85-24	7112HP	252	7030HP						
14.00-24	17.5L-24 16.9-24 420/85-28	7115HP	266	7030HP						
16.00-24 16.00-25	19.5L-24 18.4-26 18.4-24				7127HP	425	7040HP			
16.00-20 17.5-25					7124HP	421	7040HP			
18.00-25 20.5-25 550/65-25 525/80-25	18.4-30 21L-24 480/85-30				7133HP	498	7050HP			
23.5-25 25x65-25 2100-25 20.8-34	23.1-26 18.4-34 480/85-34							7145HP	706	7060HP
26.5-25 26.5-29 24.00-25 750/65-25	24.5-32							7157HP	788	7070HP
29.5-25	30.5-32 580/85-42							7172HP	844	7080HP
29.5-29	710/70-38							7175HP	788	7080HP

TITAN DIAMOND

- Alloy Square Link Chains
- For Plows, Graders, Loaders, etc.
- Continuous Diamond Pattern for smoothest ride
- Link over Link with Wear Bars
- Pull Chain Tightening System

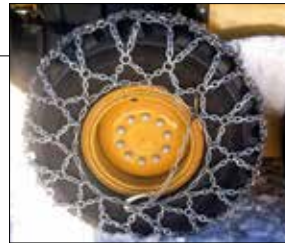

Tire Size		10mm			11.1mm			11.1mm		
		Regular			Regular			Regular		
Loader Grader	Back Hoe Tractor	Stock No.	Wt./ Pr.	Cross Chain No.	Stock No.	Wt./ Pr.	Cross Chain No.	Stock No.	Wt./ Pr.	Cross Chain No.
13.00-24 14.00-20 15.5-25	13.6-28 420/70-24 385/85-24	7112DLW	338	7112DLW-EXT						
14.00-24	17.5L-24 16.9-24 420/85-28	7115DLW	376	7115DLW-EXT						
16.00-24 16.00-25	19.5L-24 18.4-26 18.4-24				7127DLW	480	7127DLW-EXT			
16.00-20 17.5-25					7124DLW	472	7127DLW-EXT			
18.00-25 20.5-25 550/65-25 525/80-25	18.4-30 21L-24 480/85-30				7133DLW	556	7133DLW-EXT			
23.5-25 25x65-25 2100-25 20.8-34	23.1-26 18.4-34 480/85-34							7145DLW	596	7145DLW-EXT
26.5-25 26.5-29 24.00-25 750/65-25	24.5-32							7157DLW	710	7157DLW-EXT
29.5-25	30.5-32 580/85-42							7172DLW	816	7172DLW-EXT
29.5-29	710/70-38							7175DLW	870	7175DLW-EXT

SKID STEER/LOADER SQUARE LINK TIRE CHAIN

- Heavy Duty 8mm Square Link chain provides longer life
- Designed for added traction for Off-Road or Plowing
- 2 & 4 link spacing available



2 Link Spacing

4 Link Spacing

(Packed 1 Pair Per Bag)

Tire Size	2 Link Spacing		4 Link Spacing		Cross	Wire Size
	Stock No.	Wt./Pr.	Stock No.	Wt./Pr.		
27x8.50-15 8-16.5	SS8S-2	64	SS8S	44	6263S	8mm
10-16.5 265/70-16.5	SS10S-2	76	SS10S	49	6263S	8mm
12-16.5 33x12x20	SS12S-2	92	SS12S	56	6445SP	8mm
33x15.5x16.5 14-17.5 355/80-18 36x14-20 355/55-625 370/70-16.5 355/55-625	SS14S-2	99	SS14S	61	6445SP	8mm
365/70-18	SS18S-2	109	SS18S	65	7414S	8mm

FORKLIFT TIRE CHAIN

- Provides added traction
- 2 & 4 link spacing available

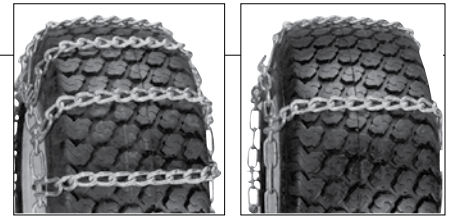

2 Link Spacing

4 Link Spacing

(Packed 1 Pair Per Bag)

Tire Size	2 Link Spacing		4 Link Spacing	
	Stock No.	Wt./Pr.	Stock No.	Wt./Pr.
6.50-10	1410-2	31	1410	18
7.50-10 25x8.50-14 7.00-12	1415-2	37	1415	22
7.00-14 27x8.50-15 28x9.50-15 7.00-15 28x9-15 29x8-15	1420-2	39	1420	24
7.50-15 9x14.50	14252	39	1425	29
23x10.50-12	1430-2	37	1430	22
250-15 27x10.50-15	1435-2	41	1435	24
8.25-15 8.15-15 300-15 315/70-15 7.50-16	1440-2	52	1440	31
14-17.5	1445-2	75	1445	45

MODIFIABLE FORKLIFT CABLE CHAIN

- 2-link spacing
- For limited clearance and smooth ride

(Packed 1 Pair Per Bag)

Tire Size	Stock No.	Wt./Pr.
6.50-10 7.00-12 27x8.50x15 21x8-9	1400F-12	22
2.50x15-15 7.00-15 7.50-15 8.5-15 8.25-15 28x9.50-15	1400F-15	27



MA2

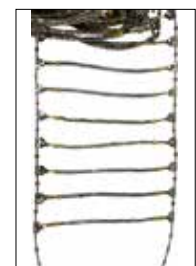

FORESTRY CHAIN



Ring Alloy or Carbon



Tight Ring Alloy



Studded Net Alloy

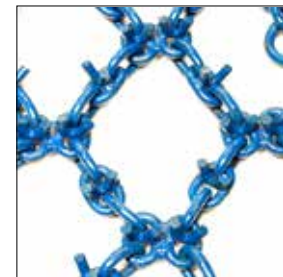

14mm - 9/16

Tire Size	Ring Carbon		Ring Alloy		Tight Ring Alloy		Studded Net Alloy	
	Stock No.	Wt./Pr.	Stock No.	Wt./Pr.	Stock No.	Wt./Pr.	Stock No.	Wt./Pr.
18.4-26 16.9-30	R184C-14MM	633	R184A-14MM	629				
23.1-26 18.4-34	R231C-14MM	762	R231A-14MM	757				

16mm - 5/8

23.1-26 18.4-34	R231C-16MM	786	R231A-16MM	754			DD231A-16MM	928
28L-26: 24.5-32	R245C-16MM	884	R245A-16MM	805	R245TA-16MM	871	DD245A-16MM	993
30.5-32	R305C-16MM	842	R305A-16MM	945	R305TA-16MM	995	DD305A-16MM	1109
35.5-32	R355C-16MM	912	R355A-16MM	1136	R355TA-16MM	1133	DD355A-16MM	1174
700/50-26.5							DD700A-16MM	810
700/55-34							DD734A-16MM	1121

19mm - 3/4

28L-26: 24.5-32			R245A-19MM	1104	R245TA-19MM	1151	DD245A-19MM	1310
30.5-32			R305A-19MM	1219	R305TA-19MM	1278	DD305A-19MM	1782
35.5-32			R355A-19MM	1273	R355TA-19MM	1450	DD355A-19MM	1917

*Other sizes available

SNOW BLOWER AND GARDEN TRACTOR CHAIN

- 2 & 4 link spacing available
- Not all sizes listed - please call for more information



2 Link Spacing

(Packed 1 Pair Per Bag)

Tire Size	2 Link Cross Chain Spacing	
	Part No.	Weight Per Pair
10 x 10.5 x 2.75 10 x 2.75 9.5 x 3 10.25 x 3.25 10 x 3.5	1701	4
12 x 3 10.5 x 4.50 x 4	1703	3
4.10 x 3.50 x 4 3.40 x 3.00 x 5	1705	3
4.10 x 3.50 x 5 4.10 x 3.50 x 6 12 x 3.50 x 6 12.25 x 3.50 x 6	1707	5
5.30 x 4.50 x 6 5 x 3.50 x 6 14 x 5.00 x 6 15 x 5.00 x 6 15 x 6.00 x 6 15 x 6.50 x 8 13 x 4 x 8	1709	9
10 x 6 x 6 12.5 x 4.50 x 6 12 x 7 x 4 13 x 5 x 6 13.00 x 4.00 x 5 13 x 4 x 6 13 x 5.00 x 9	1711	9
4.00 x 4.80 x 8 4.80 x 12	1713	11
5.00 x 5.70 x 8	1715	15
16 x 6.50 x 8	1717	12
18 x 6.50 x 8	1719	14
18 x 8.50 x 8 15 x 7.50 x 8	1721	15
18 x 9.50 x 8 18 x 8.50 x 10 9 x 9.50 x 8	1723	16
20 x 10 x 8 20 x 9 x 10 20 x 10 x 10 22 x 10 x 8 21 x 8 x 10	1725	20
20 x 8 x 8 20 x 9.00 x 8 20 x 8.00 x 10 21 x 7 x 10	1727	19
6 x 12 23 x 7.50 x 12 7 x 12	1729	21
8 x 12 23 x 8.50 x 12 23 x 8.50 x 14	1731	22
12 x 12 24 x 10.50 x 12 26 x 10 x 12 26 x 11 x 12 26 x 12 x 12 27 x 12 x 12	1733	31
22 x 11 x 8 22 x 11 x 10 23 x 9.50 x 12 23 x 10.50 x 12 24 x 9.50 x 12	1735	24
24 x 12 x 12	1737	25
8 x 15 25 x 8.50 x 14 27 x 8.50 x 15 7 x 14	1739	28
27 x 9.50 x 15	1741	34
25.5 x 12 x 9 26 x 13.00 x 10 29 x 12 x 15	1743	66
12.4 x 16 31 x 15.50 x 15 33 x 12.50 x 15	1745	97
8 x 16	1747	32
6.00 x 16	1749	41

ALL TERRAIN VEHICLE TIRE CHAIN

- Should be fitted before use
- 2 & 4 link spacing available

(Packed 1 Pair Per Bag)



Tire Size	2 Link Spacing		4 Link Spacing	
	Part No.	Weight Per Pair	Part No.	Weight Per Pair
23x8x11 24x8x11 26x8x12	ATV3-2	29	ATV3-4	17
25x8x11 25x8x10	ATV5-2	33	ATV5-4	19
22x11x8 22x12x8 22x11x10 22x10x10 23x10x10	ATV7-2	27	ATV7-4	13
24x9x10 25x10x12 24x11x10 24x11x9 25x8x12	ATV9-2	39	ATV9-4	20
25x11x12 25x13x9 25x13.5x9 25x12x9 25x12x10 24x12x10	ATV11-2	39	ATV11-4	19
24x13x9 24x13x12	ATV12-2	40	ATV12-4	23

CROSS CHAIN (Continuous)

Round Twist Carbon

Nominal Size	Chain Diameter			Std. Pkg.	Hardened	
					Stock No.	Wt./Pkg.
1/0	4.8mm	3/16	.177	100'	177CC	24
3/0	5.2mm	13/64	.207	100'	207CC	39
4/0	5.5mm	7/32	.218	100'	218CC	47
6/0	7mm	9/32	.281	100'	281CC	64
7/0	8mm	5/16	.312	50'	312CC	40
9/0	10mm	3/8	.375	50'	375CC	68
11/0	11.5mm	7/16	.437	50'	437CC	92
14/0	13mm	17/32	.531	50'	531CC	136



Regular Round

V-Bar

Nominal Size	Chain Diameter			Std. Pkg.	V-Bar	
					Stock No.	Wt./Pkg.
4/0	5.5mm	7/32	.218	100'	218CCV	59
6/0	7mm	9/32	.281	50'	281CCV	44
7/0	8.2mm	5/16	.312	50'	312CCV	48
9/0	10mm	3/8	.375	50'	375CCV	83



V - Bar

Round Twist Alloy

Nominal Size	Chain Diameter			Std. Pkg.	Round Link Alloy	
					Stock No.	Wt./Pkg.
4/0	5.5mm	7/32	.218	100	218CCA	41
6/0	7mm	9/32	.281	100	281CCA	61
7/0	8mm	5/16	.312	50	312CCA	42
9/0	10mm	3/8	.375	50	375CCA	69
11/0	11.5mm	7/16	.437	50	437CCA	94
14/0	13mm	17/32	.531	50	531CCA	135



Round Alloy

Square Alloy

Nominal Size	Chain Diameter			Std. Pkg.	Square Link Alloy	
					Stock No.	Wt./Pkg.
4/0	5.5mm	7/32	.218	100'	218CCS	44
6/0	7mm	9/32	.281	50'	281CCS	36
7/0	8.2mm	5/16	.312	50'	312CCS	46
9/0	10mm	3/8	.375	50'	375CCS	67
11/0	11.5mm	7/16	.437	50'	437CCS	97
14/0	13mm	17/32	.531	50'	531CCS	135



Non - Twist Square Link Alloy

Twisted Square Alloy

Nominal Size	Chain Diameter			Std. Pkg.	Twisted Square Link Alloy	
					Stock No.	Wt./Pkg.
4/0	5.5mm	7/32	.218	100'	218CCST	45
6/0	7mm	9/32	.281	50'	281CCST	37
7/0	8.2mm	5/16	.312	50'	312CCST	48
9/0	10mm	3/8	.375	50'	375CCST	69
11/0	11.5mm	7/16	.437	50'	437CCST	100



Twisted Square Alloy

Studded

Nominal Size	Chain Diameter			Std. Pkg.	Studded Alloy	
					Stock No.	Wt./Pkg.
6/0	7mm	9/32	.281	50'	281STD	44
7/0	8mm	5/16	.312	50'	312STD	48
9/0	10mm	3/8	.375	50'	375STD	83



Studded

Straight Link Side Chain: Unhardened (Continuous)

Nominal Size	Chain Diameter			Std. Pkg.	Stock No.	Wt./Pkg.
1/0	4.5mm	11/64	.177	100	177SC	23
2/0	4.8mm	3/16	.192	100	192SC	28
4/0	5.5mm	7/32	.218	100	218SC	33
6/0	7mm	9/32	.281	100	281SC	53
7/0	8mm	5/16	.312	100	312SC	66
9/0	10mm	3/8	.375	50	375SC	51
11/0	11.5mm	7/16	.437	50	437SC	73
14/0	13mm	1/2	.500	50	500SC	101



*High grade self-colored available

Straight Link Side Chain: Hardened (Continuous)

Nominal Size	Chain Diameter			Std. Pkg.	Stock No.	Wt./Pkg.
7/0	8mm	5/16	.312	100	312SCH	68
9/0	10mm	3/8	.375	50	375SCH	51
11/0	11.5mm	7/16	.437	50	3437SCH	74

CAM Side Chain (Pre-cut with 4 Cams and 1 End Fastener Per Rail) T&L handle sold separately



Stock No.	End Fastener	Nominal Size	Chain Diameter			Application	Length/Pc.	Std. Pkg.	Wt./Pkg.
218SCCAM	218F	4/0	5mm	7/32	.218	Light Truck	90	10	32
281SCCAM	312F	6/0	7mm	9/32	.281	Truck	130	10	84
312SCCAM	312F	7/0	8mm	5/16	.312	Heavy Truck	130	10	83

CAMS for Side Chain

Stock No.	Nominal Size	Chain Diameter		Application	Std. Pkg.	Wt./Pkg.
CAM2	4/0	5.5mm	9/32	Light Truck	1	1
CAM3	6/0	7mm	9/32	Heavy Truck	1	1
CAM3HD	7/0	8mm	5/16	Heavy Truck	1	1



CAM Tightening Handles

Stock No.	Application
LH2	Light Truck "L" Handle
LH3	Heavy Truck "L" Handle
TH2	Light Truck "T" Handle
TH3	Heavy Truck "T" Handle



Cross Chain Hooks: Standard and Swivel

Chain Diameter	Application	Stock No.	Std. Pkg.	Wt./Pkg.
3/16	Passenger Car (1100)	177CH	50	2
13/64	Passenger Car (1200)	207CH	50	4
1/4	Light Truck	250CH	50	5
5/16	Medium Truck	312CH	50	8
3/8	Heavy Truck	375CH	50	13
13/32	Tractor	406CH	50	17
7/16	Grader	437CH	50	23
17/32	Loader (Alloy)	531CH	25	17
7/16	Heavy Truck	375JH	50	12
7/16	Tractor/Grader	437JH	50	22
17/32	Loader	531JH	50	29



*High grade alloy available

Speed Hooks

Stock No.	Chain Diameter		Inside Pitch	Application	Std. Pkg.	Wt./Pkg.
250SH	.250	1/4	1-7/8	Garden Tractor	25	1
281SH	.281	9/32	2-1/8	Light Truck	25	1
344SH	.344	5/16	2-1/2	Medium Truck	25	2
375SH	.375	3/8	2-1/8	Heavy Truck	25	4
406SH	.406	7/16	3	Off Road	25	7



Cross Chain Repair Links

Stock No.	Chain Diameter		Application	Std. Pkg.	Wt./Pkg.
207CCRL	.207	13/64	Passenger Car	50	1
250CCRL	.250	1/4	Light Truck	50	2
281CCRL	.281	9/32	Medium Truck	50	4
312CCRL	.312	5/16	Heavy Truck	50	5



Side Chain Repair Links

Stock No.	Chain Diameter		Inside Pitch	Application	Std. Pkg.	Wt./Pkg.
250SCRL	.250	1/4	1-1/4	Light Truck	50	3
312SCRL	.312	5/16	1-1/2	Medium Truck	50	6
375SCRL	.375	3/8	1-5/8	Grader	50	11
531SCRL	.531	17/32	3-1/4	Giant OTR	10	6



Quick Links

Fast, easy connectors for permanent or temporary attachment. Applications with carbon chain only. Not for Heavy Duty use.

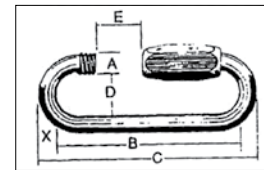

Stock No.	Trade Size Inch. MM		Dimensions, Inches						Weight/ Each	WLL / LBS	Pieces Per Bag
			A	B	C	D	E				
QL125	1/8	3.5	0.188	1.125	1.375	0.375	0.188	0.02	220	10	
QL192	3/16	5.0	0.281	1.500	1.875	0.500	0.250	0.04	610	10	
QL281	1/4	6.0	0.375	1.750	2.250	0.563	0.281	0.08	880	10	
QL312	5/16	8.0	0.500	2.313	2.875	0.688	0.375	0.16	1540	10	
QL375	3/8	9.0	0.500	2.438	3.125	0.750	0.438	0.24	1980	10	
QL437	7/16	10.0	0.531	2.688	3.500	0.813	0.500	0.38	2920	10	
QL531	1/2	12.0	0.594	3.188	4.125	0.938	0.625	0.56	3300	10	

REPLACEMENT PARTS AND PIECES FOR TITAN DIAMOND

Stock No.	Application	Std. Pkg.	Wt./Pkg.
QH-1	1500, 2300, 2500 Series Quick Hook	10	0.15
LS-1	1500, 2300, 2500 Series Lock System	10	0.2
RE-1	1500, 2300 Series Rubber End	10	0.25
RE-2	2500 Series Rubber End	10	0.25
RK-1	1500, 2300 Series 4 pc Repair Kit	10	0.22
RK-2	2500 Series 4 pc Repair Kit	10	0.22
SH-1	1500, 2300, 2500 Series Shortening Hook	10	0.06



Side Chain Fasteners

Stock No.	Application	Overall Length	Std. Pkg.	Wt./Pkg.
192F	Passenger & Light Truck	3"	25PCS.	2

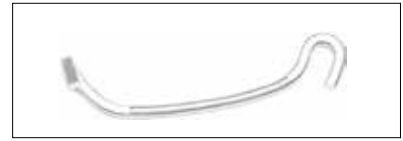

218F	Light Truck	4"	25PCS.	6
312F	Medium & Heavy Truck	6"	25PCS.	11



215FB	Light Truck Fastener	5"	100PC.	29
312FB	Heavy Truck Fastener	7"	100PC	49



375F	Tractor	5"	25PC.	14
437F	Heavy Grader	6"	25PC.	26



Shoe Chain - Spike

Stock No.	Application	Std. Pkg.	Wt./Pkg.
SC-HX-S-M	S, M 7.5-10	1	0.5
SC-HX-L-XL	L, XL 10.5-13	1	0.5



Shoe Chain - Link

Stock No.	Application	Overall Length	Std. Pkg.	Wt./Pkg.
SC-M	Shoe Size 7-8 1/2	Medium	1	0.5
SC-L	Shoe Size 9-13	Large	1	0.5
SC-XL	Shoe Size Over 13	Extra Large	1	0.5



Chain Repair Pliers

Stock No.	Application	Overall Length	Std. Pkg.	Wt./Pkg.
RP1/RP2	Passenger Car & Light Truck	Medium	1	2
RP2S	Passenger Car & Light Truck	13.5"	1	3
RP3	All Truck & Tractor	Large 36"	1	8
RP3S	All Truck & Tractor	Large S.H. 18"	1	7



RP1 Passenger



RP3S

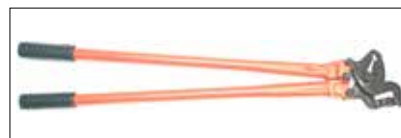

RP3



RP2 Light Truck

Chain / Bolt Cutters

Stock No.	Application	Overall Length	Std. Pkg.	Wt./Pkg.
BC18	Passenger Car	18"	1	3
BC24	Light Truck	24"	1	5
BC36	Truck/Off Road	36"	1	12

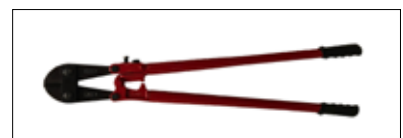

SHACKLES & G70 HOOKS

Galvanized Screw Pin Shackle

Stock No.	Diameter
S6MM	1/4
S8MM	5/16
S10MM	3/8
S11MM	7/16
S13MM	1/2
S16MM	5/8



Alloy Screw Pin Shackle

Stock No.	Diameter
SA11MM	7/16
SA13MM	1/2
SA16MM	5/8
SA19MM	3/4



Pin Coupler Shackle

Stock No.	Diameter
PC10	3/8 10mm
PC13	1/2 13mm
PC16	5/8 16mm
PC19	3/4 19mm





Stock No.	Description	WLL/LBS	Std. Pkg.
GH70-8	G70 5/16" Clevis Grab Hook	4,700 lbs	100
GH70-10	G70 3/8" Clevis Grab Hook	6,600 lbs	50
GH70-13	G70 1/2" Clevis Grab Hook	11,300 lbs	25
SLIP-G70-8-L	G70 5/16" Clevis Slip Hook with Latch	4,700 lbs	10
SLIP-G70-10-L	G70 3/8" Clevis Slip Hook with Latch	6,600 lbs	10
SLIP-G70-13-L	G70 1/2" Clevis Slip Hook with Latch	11,300 lbs	10

Tire Chain Adjusters

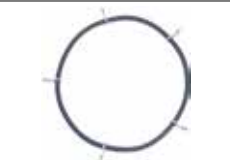
Stock No.	Adjuster Type	Application	Std. Pkg.	Wt./Pkg.
OA1	RA1 / Rubber	Passenger Car	30 PR	16
OA2	RA10 / Rubber	Light Truck	30 PR	19
OA3	RA20 / Rubber	Heavy Truck	30 PR	42

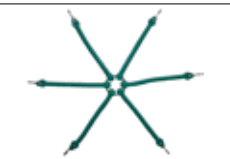

MA1	Rubber Multi-Arm (6)	Passenger Car	30 PR	20
MA2	Rubber Multi-Arm (6)	Light Truck	30 PR	26
MA3	Rubber Multi-Arm (6)	Heavy Truck	30 PR	47
MA4	Rubber Multi-Arm (7)	Tractor	10 PR	30
MA7	Rubber Multi-Arm (7)	Garden/ATV	30 PR	23



SA2	#2 / Spring	Light Truck	1 PR	1
SA3	#3 / Spring	Heavy Truck	1 PR	5
SA4	#4 / Spring	Tractor	1 PR	8



TA4	Bolt & Chain	Tractor	1 PR.	21
-----	--------------	---------	-------	----



Rubber Tarp Straps (with Hooks)

Stock No.	Strap Size	Std. Pkg.	Wt.
TS9	9" Rubber Tarp Strap	50	10
TS15	15" Rubber Tarp Strap	50	13
TS21	21" Rubber Tarp Strap	50	14
TS31	31" Rubber Tarp Strap	50	20
TS41	41" Rubber Tarp Strap	50	22.50





Replacement Cross Chains

Stock No.	Std. Pkg.	Wt./Pkg.	Link Wire Diameter	No. Links	Hook Wire Diameter	Hook Stock No.	Inside Length W/Hooks (Inch)
5214	25	6	3/0 .207	7	13/64 .207	207CH	10.18
5220	25	8	3/0 .207	9	13/64 .207	207CH	12.02
5222	25	9	3/0 .207	10	13/64 .207	207CH	12.94
5224	25	11	3/0 .207	12	13/64 .207	207CH	13.86
5414	25	5	1/0 .177	7	11/64 .177	177CH	10.38
5419	25	6	1/0 .177	8	11/64 .177	177CH	11.56
5420	25	7	1/0 .177	9	11/64 .177	177CH	12.74
5422	25	7	1/0 .177	10	11/64 .177	177CH	13.92
5814	25	8	3/0 .207	7	13/64 .207	207CH	10.18
5820	25	9	3/0 .207	9	13/64 .207	207CH	12.02
5822	25	12	3/0 .207	10	13/64 .207	207CH	12.94
5824	25	13	3/0 .207	11	13/64 .207	207CH	13.86
6218	25	12	4/0 .218	8	1/4 .250	250CH	11.12
6219	25	12	4/0 .218	9	1/4 .250	250CH	12.12
6221	25	14	4/0 .218	10	1/4 .250	250CH	13.24
6221S	25	19	4/0 .218	11	5/16 .312	312CH	14.18
6221SHD	25	31	6/0 .281	9	5/16 .312	312CH	14.5
6221ST	25	20	4/0 .218	10	5/16 .312	312CH	14.18
6225	25	16	4/0 .218	12	1/4 .250	250CH	15.12
6225S	25	21	4/0 .218	13	5/16 .312	312CH	15.40
6225SHD	25	31	6/0 .281	11	5/16 .312	312CH	16.25
6225ST	25	22	4/0 .218	11	5/16 .312	312CH	15.12
6251	25	22	6/0 .281	9	5/16 .312	312CH	14.37
6251A	25	23	6/0 .281	9	5/16 .312	312CH	14.37
6251S	25	31	6/0 .281	9	3/8 .375	375CH	14.60
6251ST	25	32	6/0 .281	9	3/8 .375	375CH	14.37
6253	25	24	6/0 .281	10	5/16 .312	312CH	15.62
6253A	25	25	6/0 .281	10	5/16 .312	312CH	15.62
6253S	25	34	6/0 .281	11	3/8 .375	375CH	16.75
6253ST	25	35	6/0 .281	10	3/8 .375	375CH	15.62
6253STD	25	37	6/0 .281	10	3/8 .375	375CH	15.62
6256	25	31	7/0 .312	8	3/8 .375	375CH	14.62
6259	25	27	6/0 .281	12	5/16 .312	312CH	18.12
6259A	25	28	6/0 .281	12	5/16 .312	312CH	18.12
6259S	25	39	6/0 .281	13	3/8 .375	375CH	19.08
6260	25	33	7/0 .312	9	3/8 .375	375CH	16.01
6260A	25	35	7/0 .312	9	3/8 .375	375CH	16.01
6260S	25	38	7/0 .312	9	3/8 .375	375CH	15.62
6260ST	25	39	7/0 .312	9	3/8 .375	375CH	16.0
6260STD	25	35	7/0 .312	9	3/8 .375	375CH	16.0
6263	25	35	7/0 .312	10	3/8 .375	375CH	17.40
6263A	25	38	7/0 .312	10	3/8 .375	375CH	17.40
6263S	25	41	7/0 .312	11	3/8 .375	375CH	18.75
6263ST	25	42	7/0 .312	11	3/8 .375	375CH	17.4
6263STD	25	46	7/0 .312	11	3/8 .375	375CH	17.4
6265	25	39	6/0 .281	16	3/8 .375	375CH	23.12
6266	25	36	7/0 .312	11	3/8 .375	375CH	18.79
6267	25	35	6/0 .281	17	5/16 .312	312CH	24.37
6445SP	25	54	7/0 .312	13	3/8 .375	375CH	20.90
6434	25	55	9/0 .375	11	13/32 .406	406CH	17.36
6436	25	57	9/0 .375	12	13/32 .406	406CH	18.75
6438	25	61	9/0 .375	13	13/32 .406	406CH	20.50

Proper Cross Chain measurement:
Inside of hook to Inside of hook



Replacement Cross Chains

Stock No.	Std. Pkg.	Wt./Pkg.	Link Wire Diameter	No. Links	Hook Wire Diameter	Hook Stock No.	Inside Length W/Hooks (Inch)
6445	25	66	9/0 .375	14	13/32 .406	406CH	21.14
6630S	10	35	9/0 .375	15	7/16 .437	437CH	25.50
6640S	10	56	11/0 .437	17	1/2 .531	531CH	28.00
6650S	10	62	11/0 .437	19	1/2 .531	531CH	33.75
6660S	5	48	14/0 .531	21	1/2 .531	531CH	39.25
6670S	5	56	14/0 .531	25	1/2 .531	531CH	44.75
6680S	5	64	14/0 .531	29	1/2 .531	531CH	50.25
6630	10	30	9/0 .375	17	13/32 .406	406CH	25.00
6640	10	44	11/0 .437	15	7/16 .437	437CH	28.00
6650	10	51	11/0 .437	19	7/16 .437	437CH	34.40
6660	5	45	14/0 .531	19	1/2 .531	531CH	39.30
6670	5	51	14/0 .531	22	1/2 .531	531CH	44.50
6680	5	60	14/0 .531	26	1/2 .531	531CH	51.50
6818	25	13	4/0 .218	8	1/4 .218	250CH	11.12
6819	25	15	4/0 .218	9	1/4 .218	250CH	12.12
6821	25	16	4/0 .218	10	1/4 .218	250CH	13.12
6822	25	26	6/0 .281	9	5/16 .312	312CH	14.37
6823	25	17	4/0 .218	11	1/4 .250	250CH	14.08
6825	25	19	4/0 .218	12	1/4 .250	250CH	15.12
6827	25	21	4/0 .218	14	1/4 .250	250CH	17.10
6853	25	28	6/0 .281	10	5/16 .312	312CH	15.64
6858	25	25	6/0 .281	11	3/8 .375	375CH	17.25
6859	25	32	6/0 .281	12	5/16 .312	312CH	18.12
6860	25	37	7/0 .312	9	3/8 .375	375CH	16.01
6863	25	39	7/0 .312	10	3/8 .375	375CH	17.40
6865	25	41	6/0 .281	16	3/8 .375	375CH	23.12
6866	25	44	7/0 .312	11	3/8 .375	375CH	18.79
7213	25	43	7/0 .312	13	3/8 .375	375CH	21.57
7214	25	45	7/0 .312	14	3/8 .375	375CH	22.96
7215	25	47	7/0 .312	15	3/8 .375	375CH	24.35
7216	25	60	7/0 .312	20	3/8 .375	375CH	31.30
7420	25	72	9/0 .375	16	13/32 .406	406CH	23.66
7426	10	33	9/0 .375	19	13/32 .406	406CH	27.44
7470	25	34	7/0 .312	10	3/8 .375	375CH	17.40
7030HP	1	8	9/0 .375	15	7/16 .437	437CH	26.10
7040HP	1	12	11/0 .437	17	1/2 .531	531CH	32.75
7050HP	1	14	11/0 .437	19	1/2 .531	531CH	36.20
7060HP	1	25	14/0 .531	21	5/8 .625	625CH	42.60
7080HP	1	28	14/0 .531	25	5/8 .625	625CH	47.71
9562	10	51	11/0 .437	17	7/16 .437	437CH	31.29
9567	10	59	11/0 .437	22	7/16 .437	437CH	39.10
HP292	5	28	9/0 .375	9	3/8 .375	375CH	18.35
HP293	5	28	9/0 .375	10	13/32 .406	406CH	20.00
HP294	5	31	9/0 .375	11	13/32 .406	406CH	21.65
HP295	5	32	9/0 .375	12	13/32 .406	406CH	23.30
HP296	5	33	9/0 .375	13	13/32 .406	406CH	24.95
HP297	5	35	9/0 .375	14	13/32 .406	406CH	26.6
HP298	5	40	9/0 .375	17	13/32 .406	406CH	31.55
HP299	5	43	9/0 .375	19	13/32 .406	406CH	34.85
HP301	5	46	9/0 .375	21	13/32 .406	406CH	40.32

PLEASE
CONTACT US FOR
OUR FULL-LINE
CARGO CONTROL
CATALOG

CONTROL IS IN YOUR HANDS WITH **TITAN**

4" Winch Straps

Stock No.	Description	WLL	Qty. Per Box
LR430-1	4" x 30' Winch Strap with Flat Hook	5,400 lbs	10
LR430-3	4" x 30' Winch Strap with V-Ring	5,400 lbs	10
LR430-4	4" x 30' Winch Strap with Sewn Eye	5,400 lbs	10
LR430-5	4" x 30' Winch Strap with Chain & Hook	5,400 lbs	10



2" Ratchet Straps

Stock No.	Description	WLL	Qty. Per Box
LR22721-1	2" x 27' Ratchet Strap Assembly with Flat Hooks	3,335 lbs	10
LR22721-2	2" x 27' Ratchet Strap Assembly with Wire Hooks	3,335 lbs	10
LR23021-1	2" x 30' Ratchet Strap Assembly with Flat Hooks	3,335 lbs	10
LR23021-2	2" x 30' Ratchet Strap Assembly with Wire Hooks	3,335 lbs	10



Transport Chain

Stock No.	Description	WLL	Qty. Per Barrel
G70-8-20	G70 5/16" x 20' Assembly with Grab Hooks	4,700 lbs	25
G70-10-20	G70 3/8" x 20' Assembly with Grab Hooks	6,600 lbs	20
G70-13-20	G70 1/2" x 20' Assembly with Grab Hooks	11,300 lbs	10



Lever and Ratchet Binders

Stock No.	Description	WLL	Qty. Per Box
LB8	Lever Binder 5/16" - 3/8"	6,600 lbs	5
LB10	Lever Binder 3/8" - 1/2"	9,200 lbs	4
LB13	Lever Binder 1/2" - 5/8"	13,000 lbs	2
RB8	Ratchet Binder 5/16" - 3/8"	5,400 lbs	5
RB10	Ratchet Binder 3/8" - 1/2"	9,200 lbs	5
RB13	Ratchet Binder 1/2" - 5/8"	13,000 lbs	2



Accessories

Stock No.	Description	Qty. Per Box
LR4M	4" Steel Corner Protector	40
LR4P	4" Plastic Corner Protector	100
LR4PV12	12" Plastic "V" Board	50
LRSW	Strap Winder	10
LRWLS	Wide Load/Oversize Load Sign (18" x 84")	25



WIDE LOAD

“E” Track Ratchet Straps

Stock No.	Description	WLL	Qty. Per Box
LRE21201-7	2" x 12' Logistic Ratchet Strap w/ Spring Loaded "E" Fitting	1,000 lbs	20
LRE21601-7	2" x 16' Logistic Ratchet Strap w/ Spring Loaded "E" Fitting	1,000 lbs	20
LRE22001-7	2" x 20' Logistic Ratchet Strap w/ Spring Loaded "E" Fitting	1,000 lbs	20

**“E” Track Cam Buckle Straps**

Stock No.	Description	WLL	Qty. Per Box
LRE21202-7	2" x 12' Logistic Cam Buckle Strap w/ Spring Loaded "E" Fitting	835 lbs	20
LRE21602-7	2" x 16' Logistic Cam Buckle Strap w/ Spring Loaded "E" Fitting	835 lbs	20
LRE22002-7	2" x 20' Logistic Cam Buckle Strap w/ Spring Loaded "E" Fitting	835 lbs	20

**Interior Van Products**

Stock No.	Description	WLL	Qty. Per Box
LRRT88-1	2" x 6" Rope Tie-Off with Spring Loaded "E" Fitting	1,000 lbs	50
LRET88	Horizontal E Track - 10 Foot Section - Black Powder Coat	N/A	5
LRS804	Steel Load Lock (89"-104")	N/A	4
LREB102	Decking Beam for 102" Trailers - E/A Track Compatible	N/A	4

**1" Utility Ratchet Straps**

Stock No.	Description	WLL	Qty. Per Box
LR10901-6	1" x 9' Ratchet Strap w/ Vinyl Coated "S" Hooks	733 lbs	20
LR11201-6	1" x 12' Ratchet Strap w/ Vinyl Coated "S" Hooks	733 lbs	20
LR11501-6	1" x 15' Ratchet Strap w/ Vinyl Coated "S" Hooks	733 lbs	20
LR12001-6	1" x 20' Ratchet Strap w/ Vinyl Coated "S" Hooks	733 lbs	20

**1" Utility Cam Buckle Straps**

Stock No.	Description	WLL	Qty. Per Box
LR10902-6	1" x 9' Cam Buckle Strap w/ Vinyl Coated "S" Hooks	300 lbs	20
LR11202-6	1" x 12' Cam Buckle Strap w/ Vinyl Coated "S" Hooks	300 lbs	20
LR11502-6	1" x 15' Cam Buckle Strap w/ Vinyl Coated "S" Hooks	300 lbs	20
LR12002-6	1" x 20' Cam Buckle Strap w/ Vinyl Coated "S" Hooks	300 lbs	20

**Forged D-Ring Assemblies**

Stock No.	Description	WLL	Qty. Per Box
LRDR12	1/2" Forged D Ring Assembly w/ Weld-On Clip	4,000 lbs	50
LRDR16	5/8" Forged D Ring Assembly w/ Weld-On Clip	6,300 lbs	25
LRDR19	3/4" Forged D Ring Assembly w/ Weld-On Clip	9,000 lbs	25
LRDR25	1" Forged D Ring Assembly w/ Weld-On Clip	15,600 lbs	20

**Trailer Safety Chains**

Stock No.	Description	GVWR Class	Qty. Per Box
TSCG30-5.548-03x2	3/16" x 48" Class I Safety Chain with S Hooks	Class 1	Each
TSCG30-736-04x1	1/4" x 36" Class III Safety Chain with Single S Hook w/ Latch	Class 2 & 3	Each
TSCG70-842-06x1	5/16" x 42" Safety Chain with Clevis Slip Hook	Class 4	Each



* Not all lengths/varieties listed. Please call for more information

DEFINITIONS OF SAE CLASSIFICATIONS

1. SAE Class "S" – Regular (non - reinforced) passenger tire chains and cables for vehicles with restricted wheel well clearances.
2. SAE Class "U" – Regular (non - reinforced) and lug reinforced passenger tire chains for vehicles with regular non-restricted wheel well clearance.
3. SAE Class "W" – Those passenger tire chains that use light truck components, as well as some light truck chains.

WIRE DIAMETER CROSS REFERENCE CHART

Trade Size	Gauge	Fractional	Metric
1/0	.177inches	11/64	4.5mm
2/0	.192	3/16	4.80
3/0	.207	13/64	5.20
4/0	.218	7/32	5.54
5/0	.250	1/4	6.35
6/0	.281	9/32	7.00
7/0	.312	5/16	8.00
8/0	.344	11/32	9.00
9/0	.375	3/8	9.50
10/0	.406	13/32	10.30
11/0	.437	7/16	11.10
13/0	.500	1/2	12.70
14/0	.531	17/32	13.50

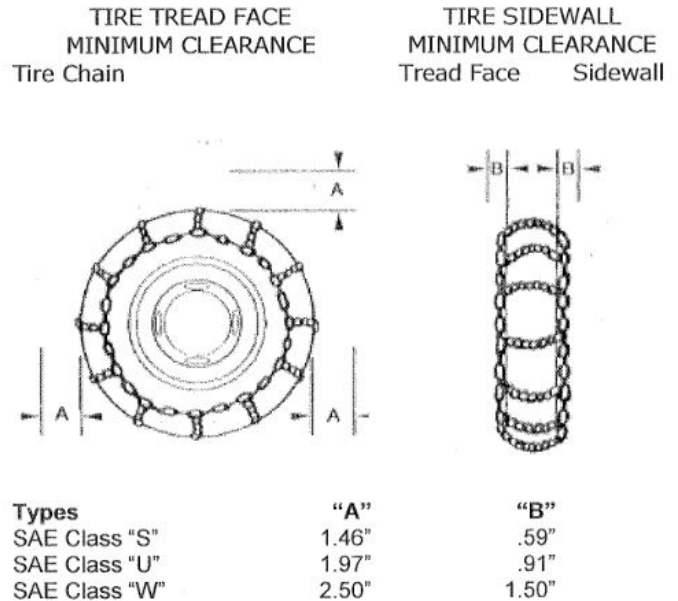

Nominal weights and dimensions are subject to tolerance of plus or minus 4%.

For specific chain regulations in each state please visit the state D.O.T. websites, several are listed below:

- Oregon** - www.oregon.gov **Nevada** - www.nevadadot.com
Washington - www.wsdot.wa.gov **Wyoming** - www.dot.state.wy
California - www.caltrans.ca.gov **Colorado** - www.dot.state.co.us

STATE CHAIN REQUIREMENTS

This is a guide only – Actual chain requirements may vary from state to state.

Chaining Diagram

Dual Axle

One set of link covering the outside tires on primary drive axle, all other positions can be cable

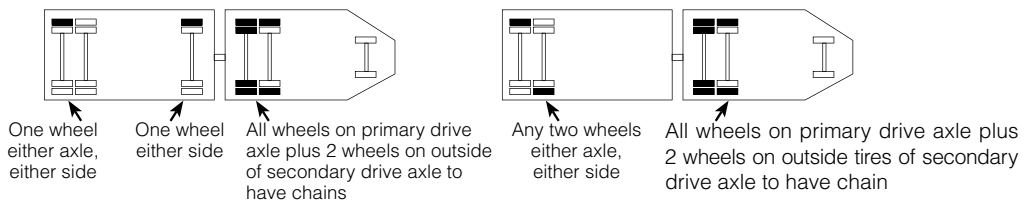

Single Axle

Link chain required on all drive tires

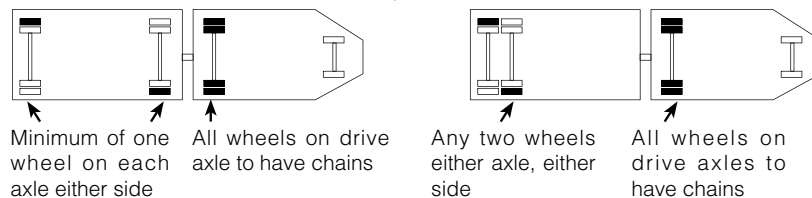

Titan Chain & Supply, LLC

6505 SW 110th Ct.

Beaverton, OR 97008

Phone: 503.644.9094

Toll Free: 855.644.9094

Fax Number: 503.644.9054

www.titanchain.com



ALL YOUR CARGO CONTROL NEEDS

**Winches
Winch Straps
Ratchet Straps
Transport Chain & Binders
Logistic Straps
Industrial**